

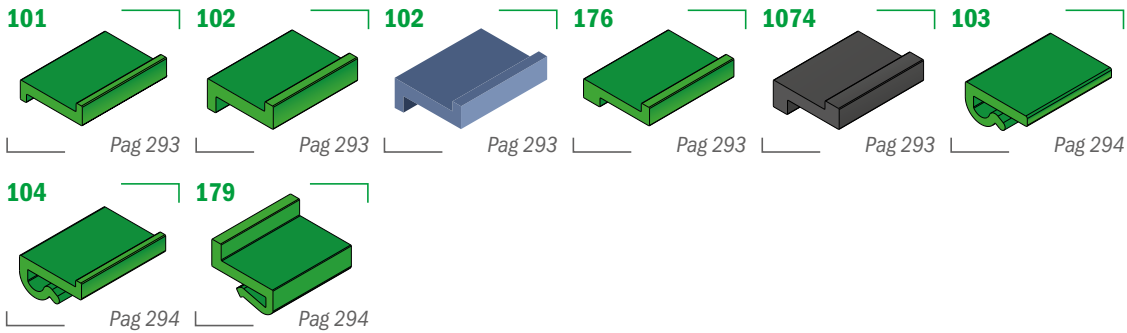

Z-Profile

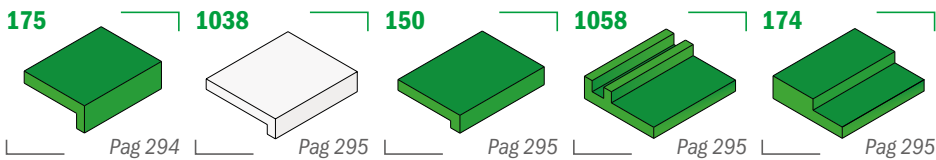

L-Profile



J-Profile

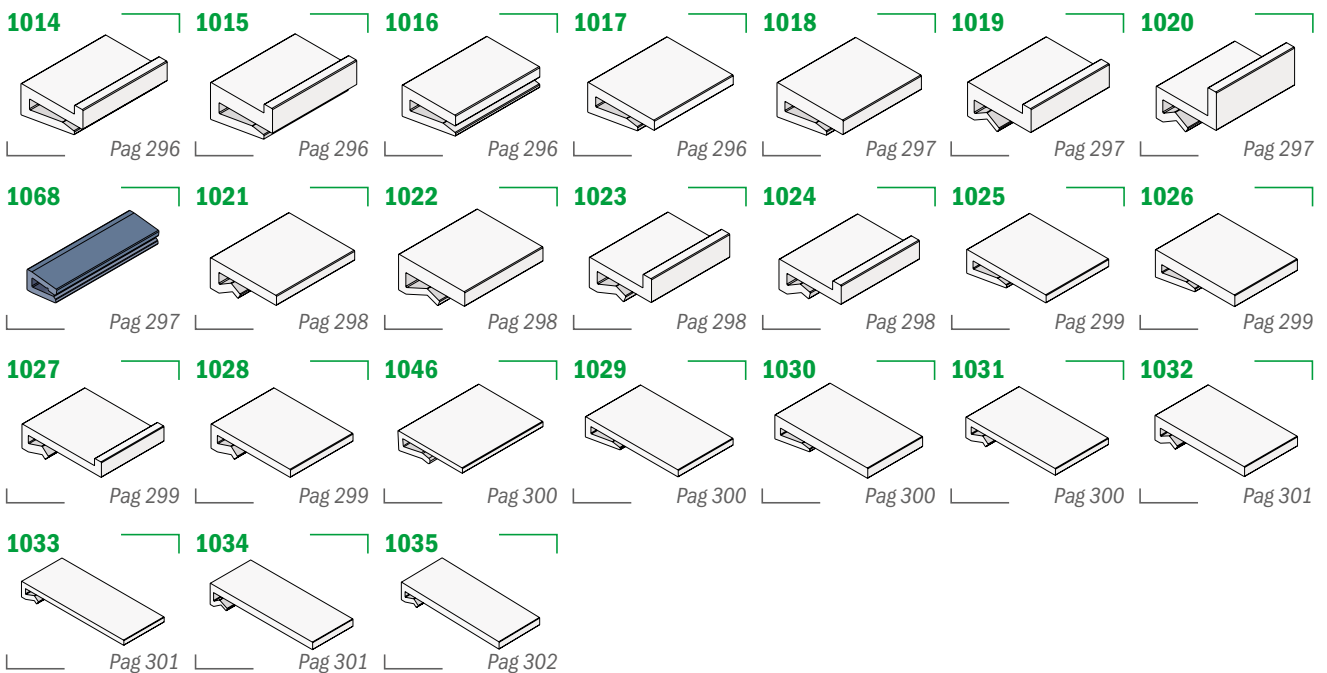

Extruded Profiles

Flat profile

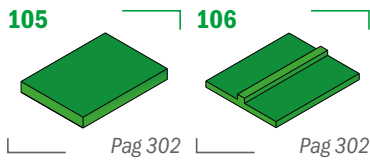

Wear strip

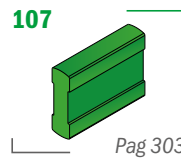

T-profile

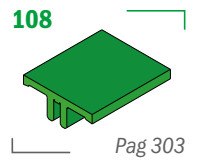

Flat clip-on

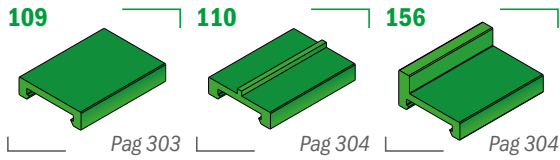

Stainless steel profile

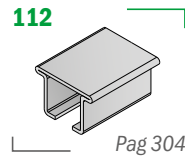

Aluminum profile

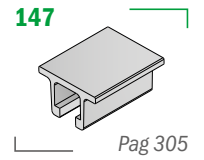

Profile assembled clip-on

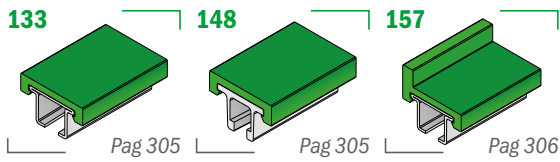

Bar cover

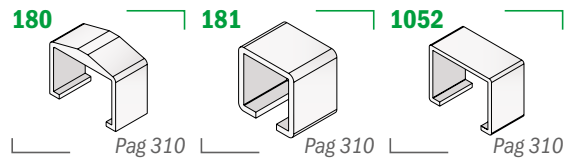

D-Profile and U-profile

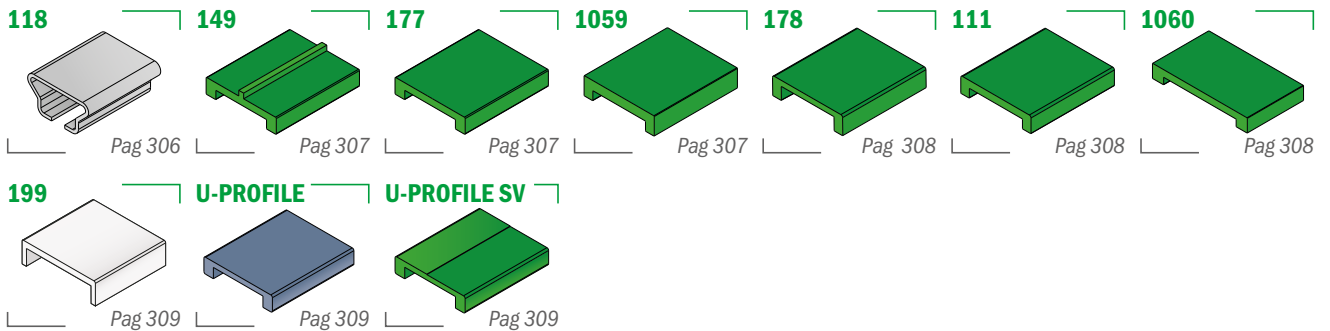

Bar cap

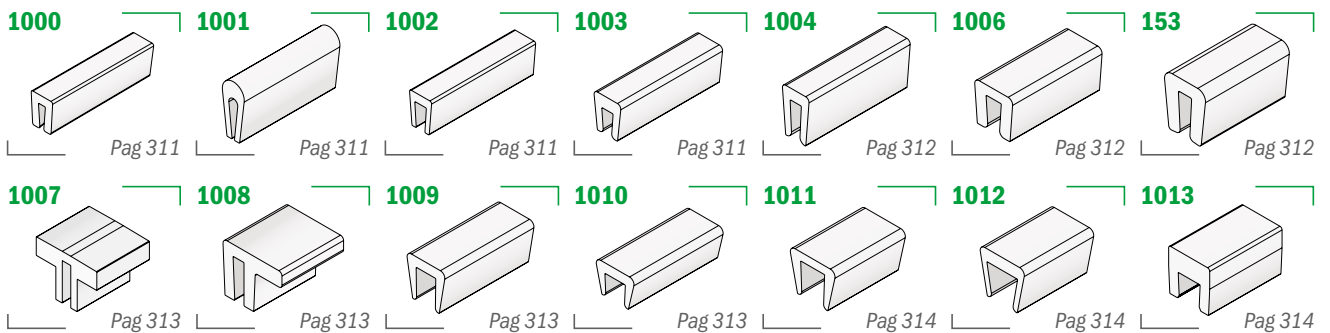

Belt side guide

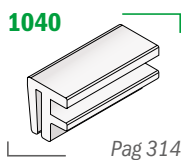

Guide rail

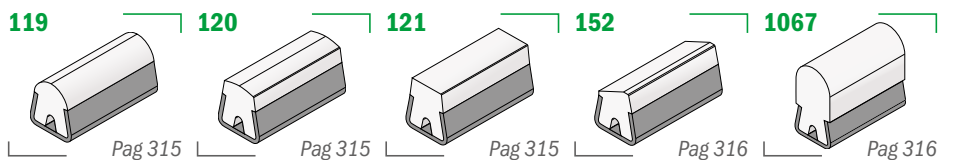

Guide rail T-shape

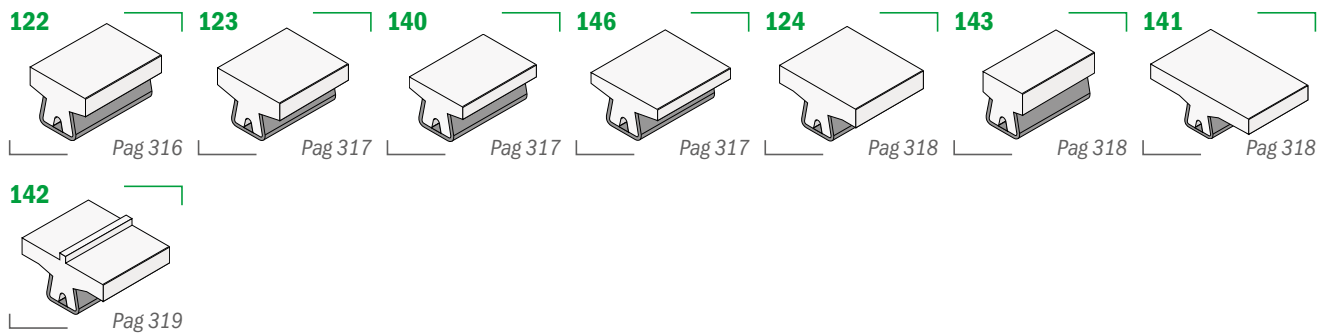

Guide rail L-shape

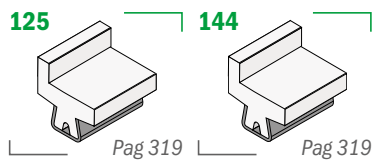

Guide rail for chain and Guide rail for label protection

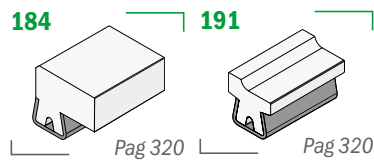

Belt side guide

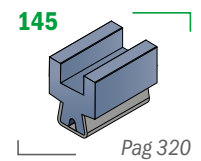

Aluminum rail for bottle guide

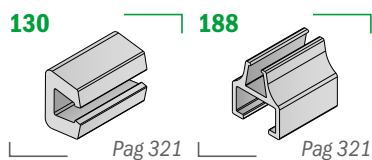

Plastic rail for bottle guide

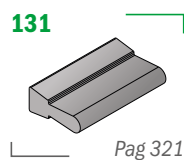

Bending machine and Roller

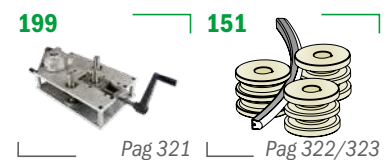

Neck guide

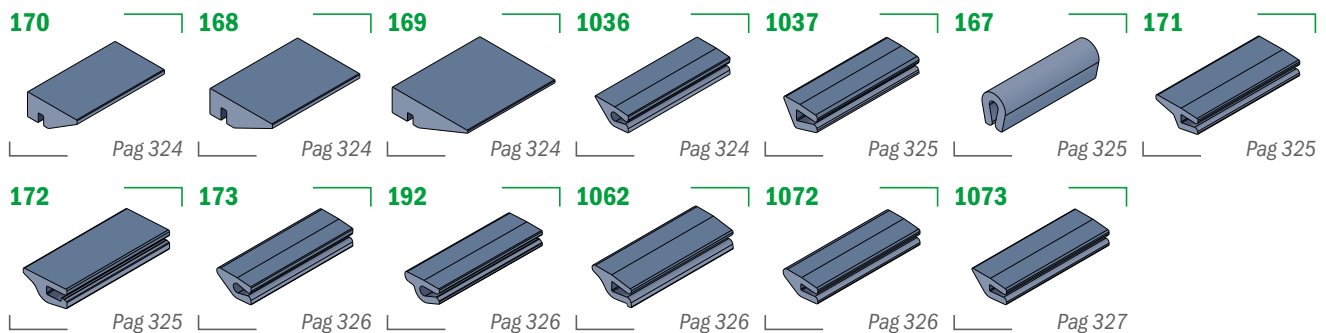

Profile for aluminum guide

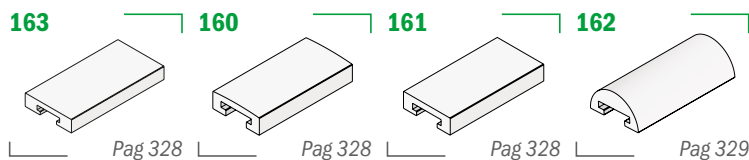

Aluminum guide

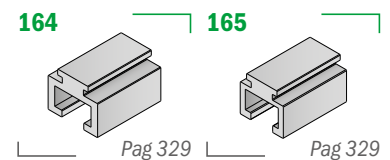

Side and Standard guide rail

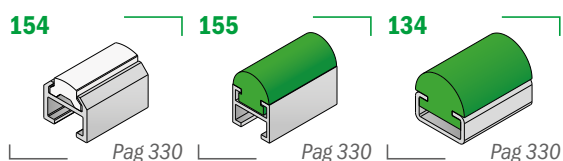

Extruded Profiles

C-Profile

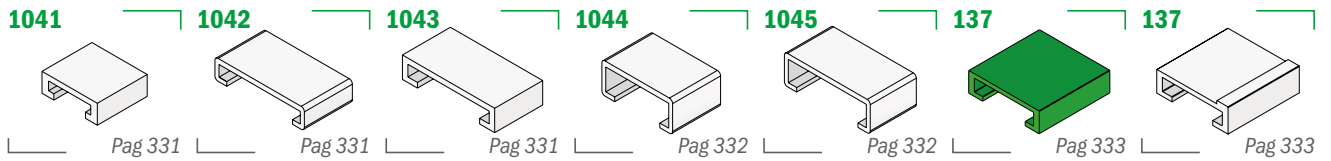

Bar cover

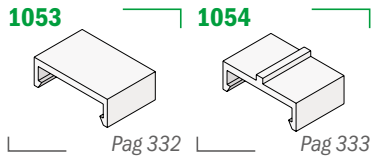

Stainless steel guide

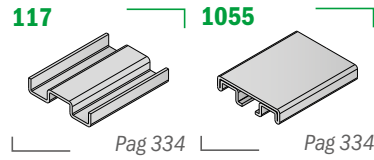

Aluminum guide

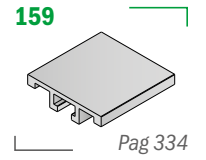

Side guide rail

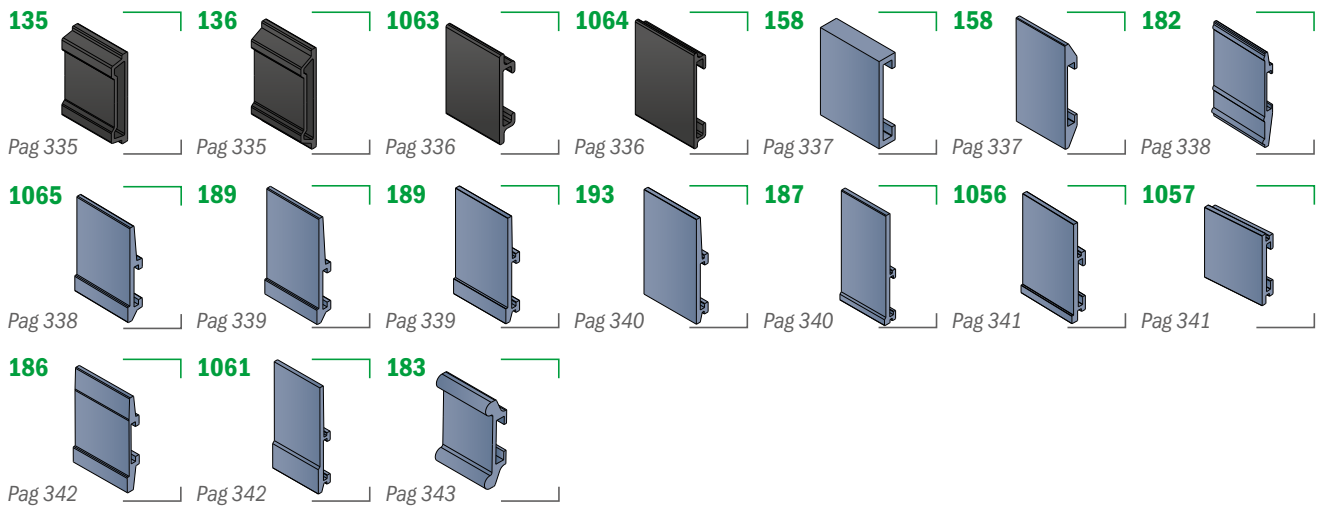

Profile for steel rods

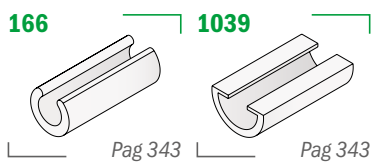

Central wear strip shoe



Side transfer guide shoe

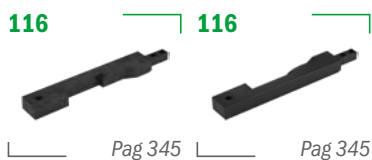

Fixing clamp

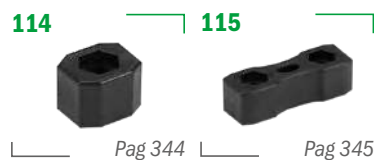

Connecting element

Material:

Polyethylene UHMW-PE with molecular density 5,600,000 g/mol
 Linear expansion coefficient: $1.1 \times 10^{-4} \text{ } ^\circ\text{F}^{-1}$ ($2 \times 10^{-4} \text{ } ^\circ\text{C}^{-1}$)
 Operating temperature: -40 to 176°F (-40 to +80°C)

101 Profilo "Z" / Z-Profile / Z-Profil

Delivery: **Easy** **Standard** On request available in white color

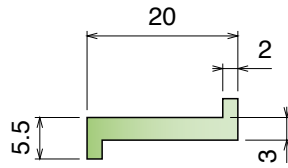
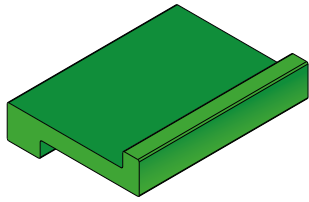

Part	Article-Nr.	Colour	Availability	Supply
101	10101	black	Stock item	60 m coils
101	10102	green	Stock item	60 m coils

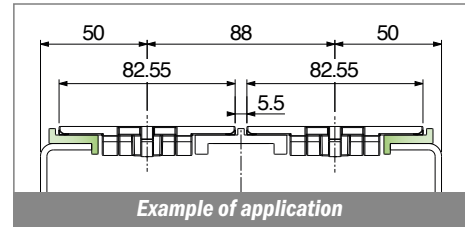

102 Profilo Z-clip rinforzato / Z-clip profile reinforced / Z Profil verstärkt

Delivery: **Easy** **Standard** On request available in white color

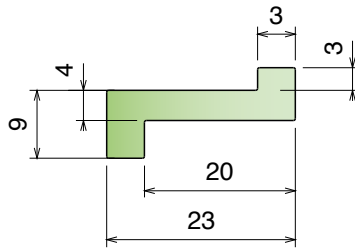
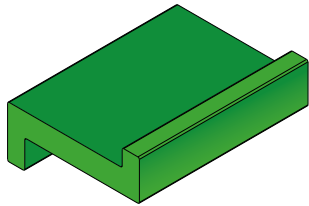

Part	Article-Nr.	Colour	Availability	Supply
102	10201	black	Stock item	60 m coils
102	10202	green	Stock item	60 m coils
102	10202B	BluLub	Stock item	60 m coils

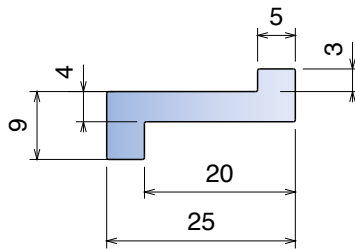
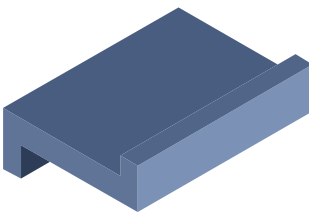

Part	Article-Nr.	Colour	Availability	Supply
102	10297	black	Stock item	60 m coils
102	10298	green	Stock item	60 m coils
102	10299B	BluLub	Stock item	60 m coils

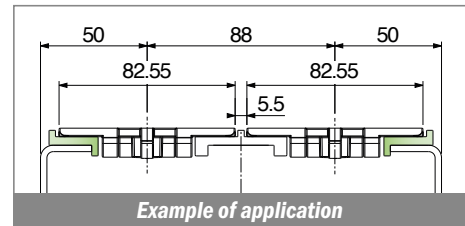

176 Profilo "Z" / Z-Profile / Z-Profil

On request available in white color

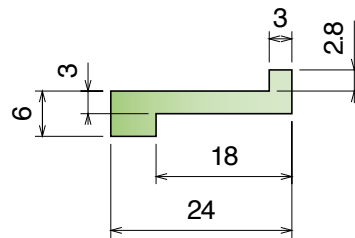
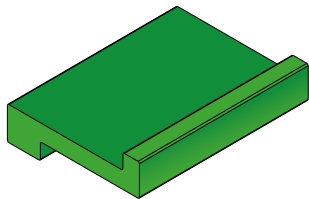

Part	Article-Nr.	Colour	Availability	Supply
176	17601	black	Stock item	60 m coils
176	17602	green	Stock item	60 m coils

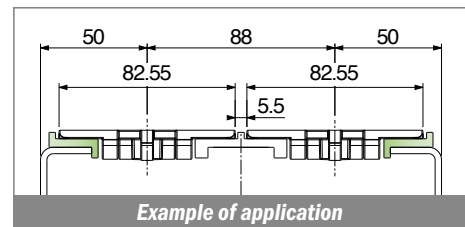

1074 Profilo "Z" / Z-Profile / Z-Profil

On request available in white color

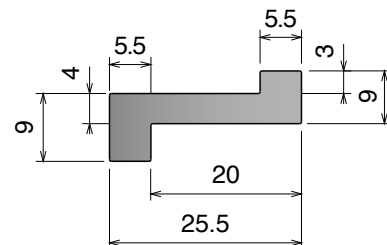
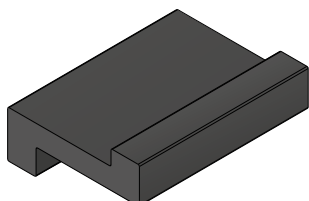

Part	Article-Nr.	Colour	Availability	Supply
1074	107401	black	Stock item	60 m coils

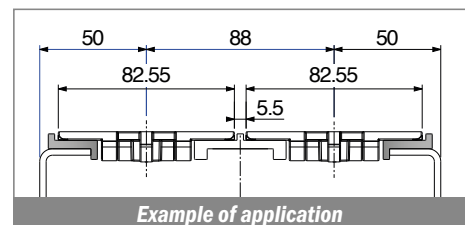

Material:

Polyethylene UHMW-PE with molecular density 5,600,000 g/mol
 Linear expansion coefficient: $1.1 \times 10^{-4} \text{ } ^\circ\text{F}^{-1}$ ($2 \times 10^{-4} \text{ } ^\circ\text{C}^{-1}$)
 Operating temperature: -40 to 176°F (-40 to +80°C)

103 Profilo Z-clip senza bordo / Z-clip profile without nose / Z Profil ohne Nase

Delivery: **Easy** **Standard** Fit on 2,5 to 3,5 mm

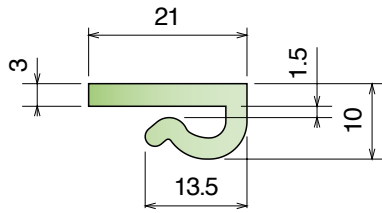
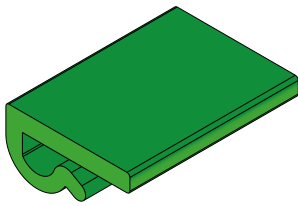

Part	Article-Nr.	Colour	Availability	Supply
103	10301	black	Stock item	60 m coils
103	10302	green	Stock item	60 m coils
103	10303	white	Stock item	60 m coils
103	10300B-30	BluLub	Stock item	30 m coils

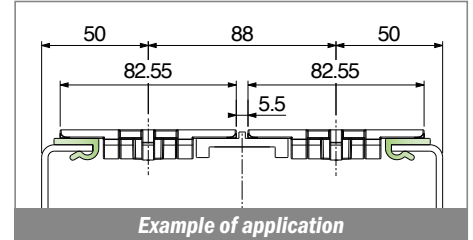

104 Profilo Z-clip con bordo / Z-clip profile with nose / Z Profil mit Nase

Delivery: **Easy** **Standard** Fit on 2,5 to 3,5 mm

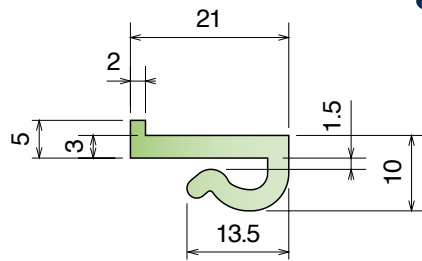
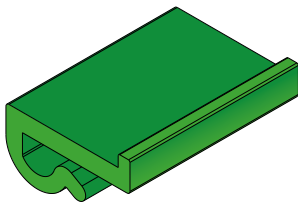

Part	Article-Nr.	Colour	Availability	Supply
104	10401	black	Stock item	60 m coils
104	10402	green	Stock item	60 m coils
104	10403	white	Stock item	60 m coils
103	10400B	BluLub	Stock item	30 m coils

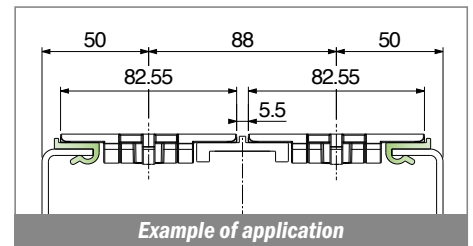

179 Profilo Z-clip con bordo / Z-clip profile with nose / Z Profil mit Nase

Delivery: **Easy** **Standard** On request available in white color | Fit on 2,5 to 3,5 mm

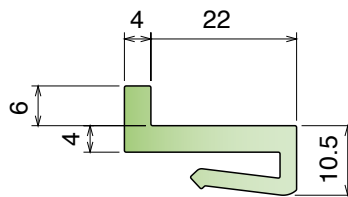
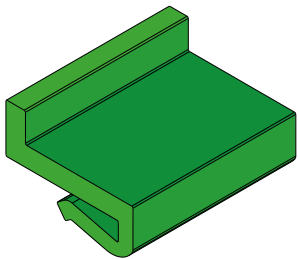

Part	Article-Nr.	L	Colour	Availability	Supply
179	17901C	3 m	black	Stock item	3 m bars
179	17901	6 m	black	On request	6 m bars
179	17902C	3 m	green	Stock item	3 m bars
179	17902	6 m	green	On request	6 m bars
179	17902-60	60 m	green	Stock item	60 m coils

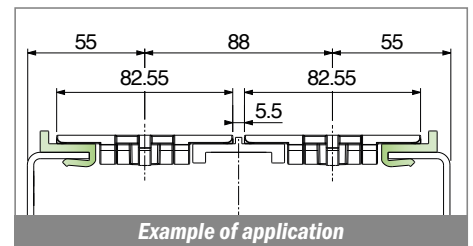

175 Profilo "L" / L-Profile / L-Profil

On request available in white color

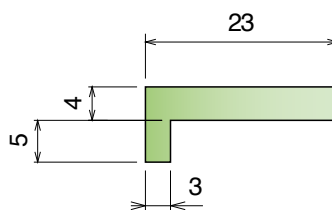
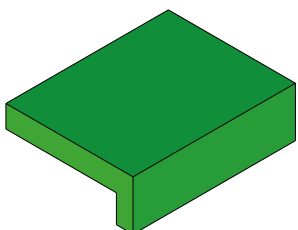

Part	Article-Nr.	Colour	Availability	Supply
175	17501	black	Stock item	60 m coils
175	17502	green	Stock item	60 m coils

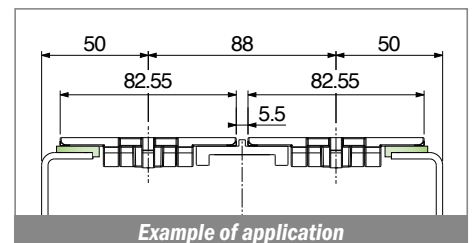

Material:

Polyethylene UHMW-PE with molecular density 5,600,000 g/mol
 Linear expansion coefficient: $1.1 \times 10^{-4} \text{ } ^\circ\text{F}^{-1}$ ($2 \times 10^{-4} \text{ } ^\circ\text{C}^{-1}$)
 Operating temperature: -40 to 176°F (-40 to +80°C)

1038

Profilo "L" / L-Profile / L-Profil

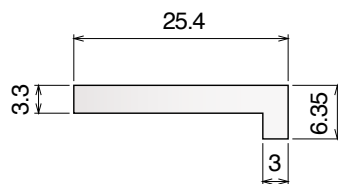
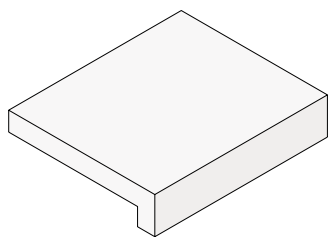

North America STANDARD

Part	Article-Nr.	L	Colour	Availability	Supply
1038	103803	60 m	white	On request	60 m coils

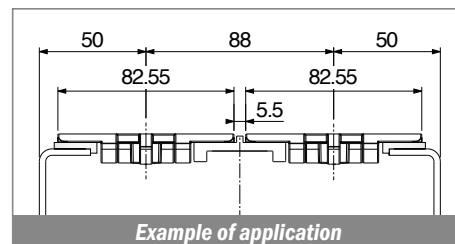

150

Profilo "L" / L-Profile / L-Profil

Delivery: **Easy** **Standard** On request available in white color

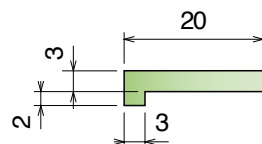
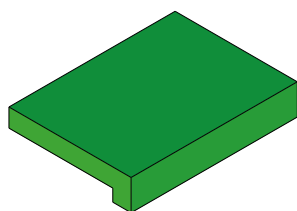

Part	Article-Nr.	Colour	Availability	Supply
150	15001	black	Stock item	60 m coils
150	15002	green	Stock item	60 m coils

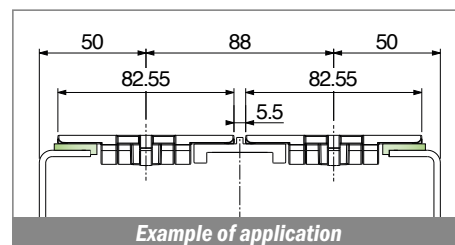

1058

Profilo "L" / L-Profile / L-Profil

On request available in white color

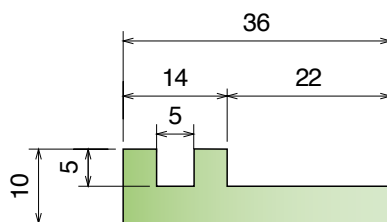
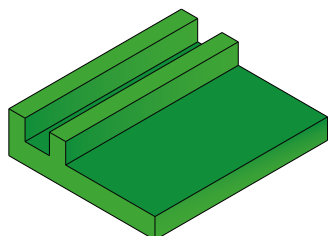

Part	Article-Nr.	L	Colour	Availability	Supply
1058	105801C	3 m	black	Stock item	3 m bars
1058	105801	6 m	black	On request	6 m bars
1058	105802C	3 m	green	Stock item	3 m bars
1058	105802	6 m	green	On request	6 m bars

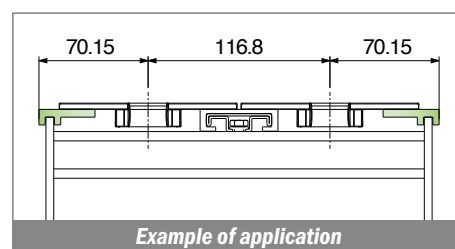

174

Profilo "L" / L-Profile / L-Profil

On request available in white color

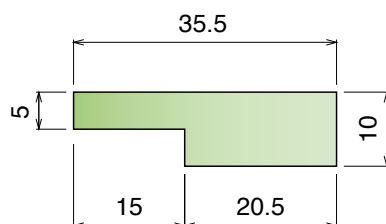
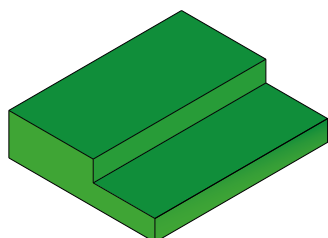

Part	Article-Nr.	L	Colour	Availability	Supply
174	17401C	3 m	black	Stock item	3 m bars
174	17401	6 m	black	On request	6 m bars
174	17402C	3 m	green	Stock item	3 m bars
174	17402	6 m	green	On request	6 m bars

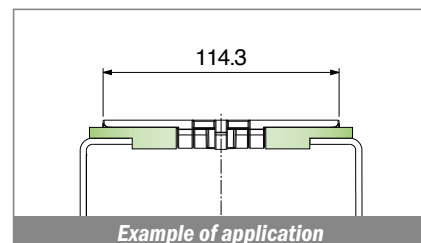

1014-1015-1016-1017

Guide estruse / Extruded profiles / Extrudiertes profil

Material:

Polyethylene UHMW-PE with molecular density 5,600,000 g/mol
 Linear expansion coefficient: $1.1 \times 10^{-4} \text{ } ^\circ\text{F}^{-1}$ ($2 \times 10^{-4} \text{ } ^\circ\text{C}^{-1}$)
 Operating temperature: -40 to 176°F (-40 to +80°C)

1014

Profilo J-Leg 19.05 / J-Leg Profile 19.05 / J Profil mit Nase 19.05

Fit on 3 mm

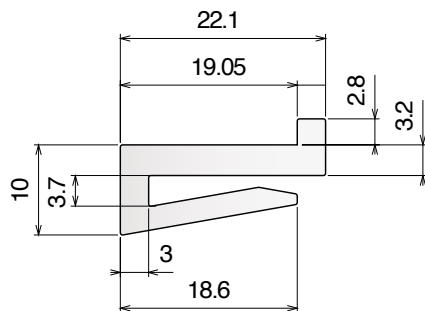
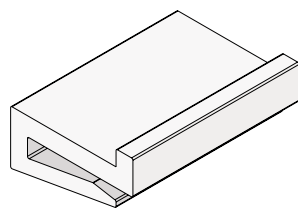

North America STANDARD

Part	Article-Nr.	L	Colour	Availability	Supply
1014	101403C	3 m	white	On request	3 m bars
1014	101403	6 m	white	On request	6 m bars

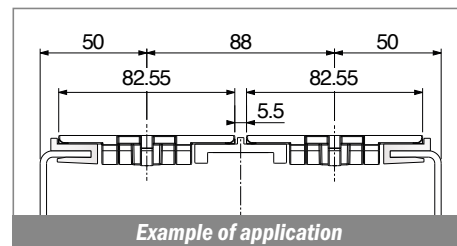

Example of application

1015

Profilo J-Leg 19.05 / J-Leg Profile 19.05 / J Profil mit Nase 19.05

Fit on 3 mm

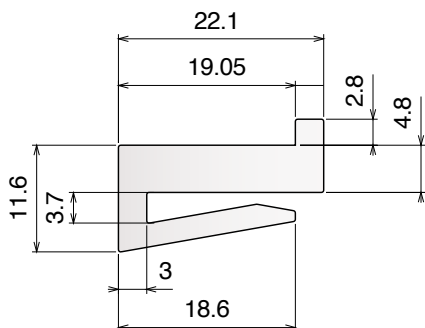
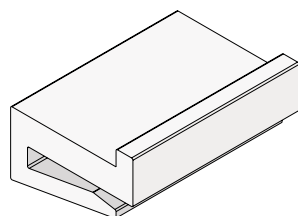

North America STANDARD

Part	Article-Nr.	L	Colour	Availability	Supply
1015	101503C	3 m	white	On request	3 m bars
1015	101503	6 m	white	On request	6 m bars

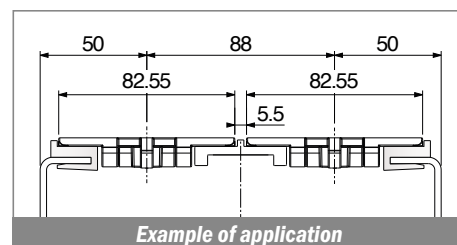

Example of application

1016

Profilo J-Leg 19.05 / J-Leg Profile 19.05 / J Profil 19.05

Delivery: **Easy** **Standard** Fit on 3 mm

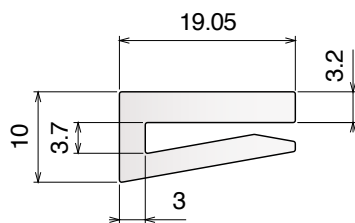
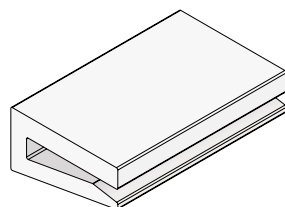

North America STANDARD

Part	Article-Nr.	L	Colour	Availability	Supply
1016	101603C	3 m	white	On request	3 m bars
1016	101603	6 m	white	On request	6 m bars
1016	101603-30	30 m	white	On request	30 m coils

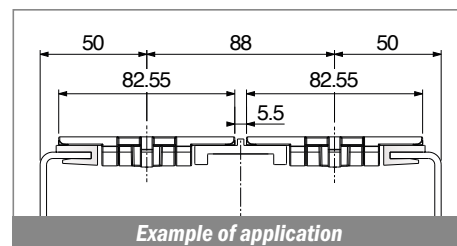

Example of application

1017

Profilo J-Leg 25.4 / J-Leg Profile 25.4 / J Profil 25.4

Delivery: **Easy** **Standard** Fit on 3 mm

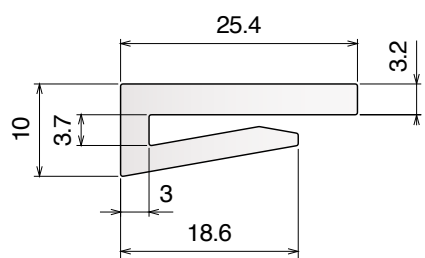
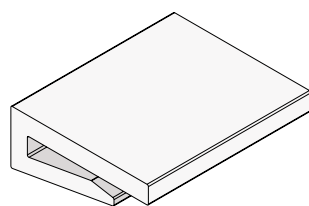

North America STANDARD

Part	Article-Nr.	L	Colour	Availability	Supply
1017	101703C	3 m	white	On request	3 m bars
1017	101703	6 m	white	On request	6 m bars
1017	101703-30	30 m	white	On request	30 m coils
1017	101703-75	75 m	white	On request	75 m coils

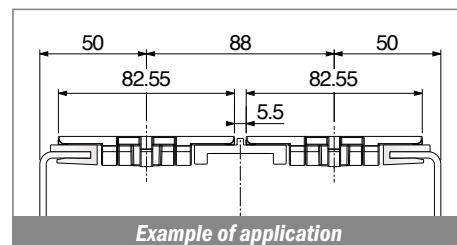

Example of application

Material:

Polyethylene UHMW-PE with molecular density 5,600,000 g/mol
 Linear expansion coefficient: $1.1 \times 10^{-4} \text{ } ^\circ\text{F}^{-1}$ ($2 \times 10^{-4} \text{ } ^\circ\text{C}^{-1}$)
 Operating temperature: -40 to 176°F (-40 to +80°C)

1018

Profilo J-Leg 25.4 / J-Leg Profile 25.4 / J Profil 25.4

Fit on 3 mm

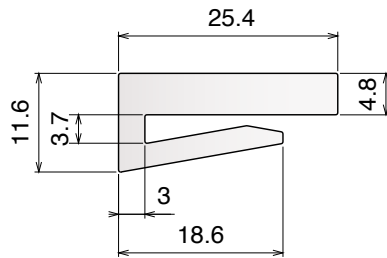
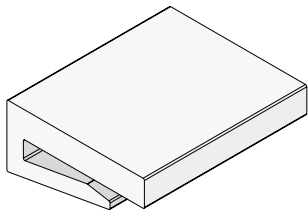

North America STANDARD

Part	Article-Nr.	L	Colour	Availability	Supply
1018	101803C	3 m	white	On request	3 m bars
1018	101803	6 m	white	On request	6 m bars

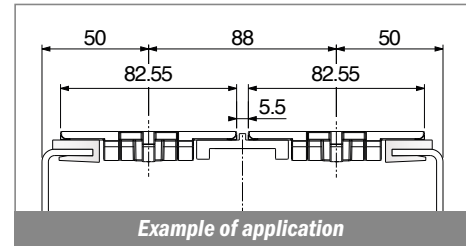

1019

Profilo J-Leg 25.4 / J-Leg Profile 25.4 / J Profil 25.4

Fit on 3 mm

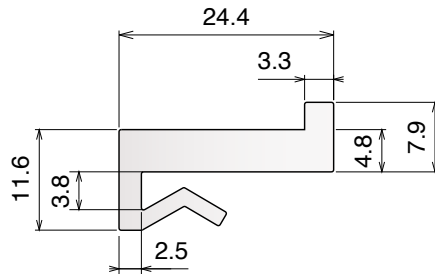
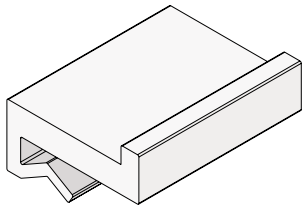

North America STANDARD

Part	Article-Nr.	L	Colour	Availability	Supply
1019	101903C	3 m	white	On request	3 m bars
1019	101903	6 m	white	On request	6 m bars

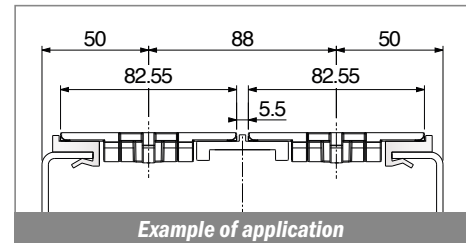

1020

Profilo J-Leg 25.4 / J-Leg Profile 25.4 / J Profil 25.4

Fit on 3 mm

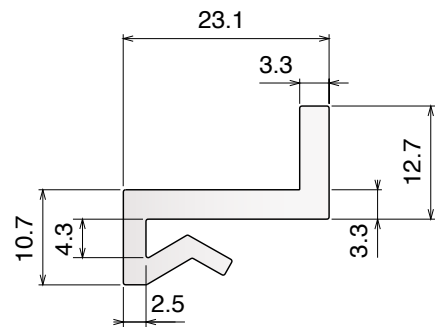
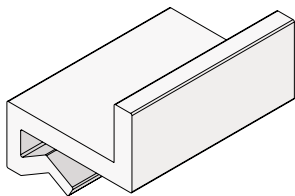

North America STANDARD

Part	Article-Nr.	L	Colour	Availability	Supply
1020	102003C	3 m	white	On request	3 m bars
1020	102003	6 m	white	On request	6 m bars

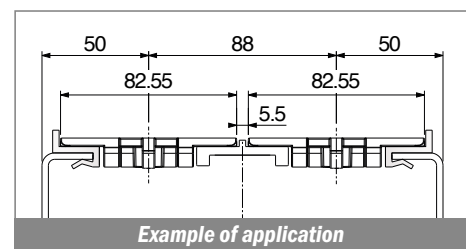

1068

Guida collo / Neck guide / Nackenführung

Fit on 1.8 - 2 mm

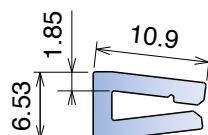
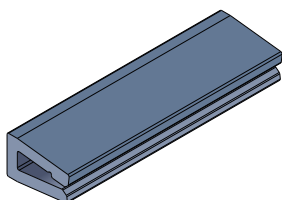

Part	Article-Nr.	L	Material	Availability	Supply
1068	106800B	30 m	BluLub	Stock item	30 m coils

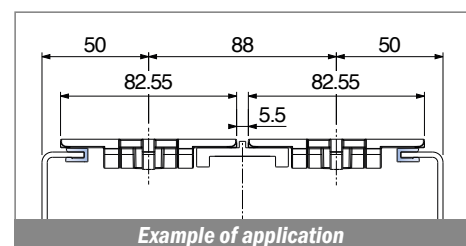

1021-1022-1023-1024

Guide estruse / Extruded profiles / Extrudiertes profil

Material:

Polyethylene UHMW-PE with molecular density 5,600,000 g/mol
 Linear expansion coefficient: $1.1 \times 10^{-4} \text{ } ^\circ\text{F}^{-1}$ ($2 \times 10^{-4} \text{ } ^\circ\text{C}^{-1}$)
 Operating temperature: -40 to 176°F (-40 to +80°C)

1021 Profilo J-Leg 25.4 / J-Leg Profile 25.4 / J Profil 25.4

Fit on 3 mm

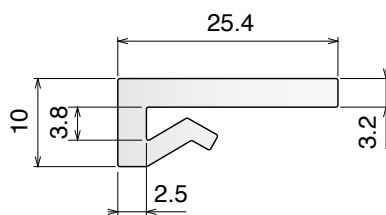
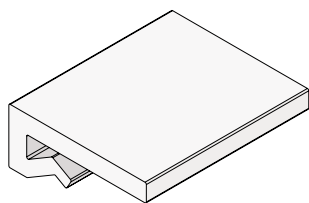

North America STANDARD

Part	Article-Nr.	L	Colour	Availability	Supply
1021	102103C	3 m	white	On request	3 m bars
1021	102103	6 m	white	On request	6 m bars
1021	102103-30	30 m	white	On request	30 m coils
1021	102103-75	75 m	white	On request	75 m coils

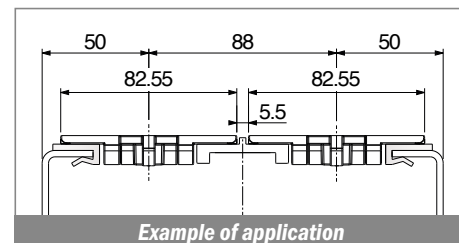

1022 Profilo J-Leg 25.4 / J-Leg Profile 25.4 / J Profil 25.4

Fit on 3 mm

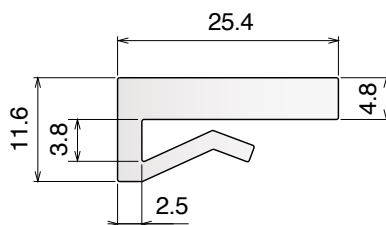
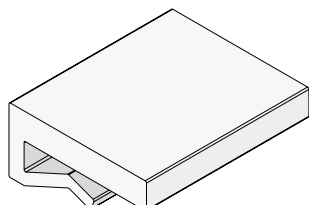

North America STANDARD

Part	Article-Nr.	L	Colour	Availability	Supply
1022	102203C	3 m	white	On request	3 m bars
1022	102203	6 m	white	On request	6 m bars
1022	102203-30	30 m	white	On request	30 m coils

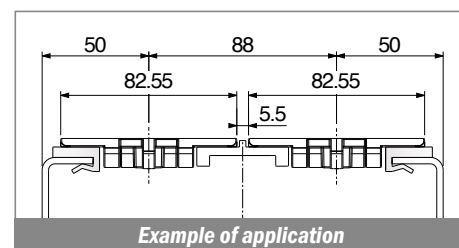

1023 Profilo J-Leg 25.4 / J-Leg Profile 25.4 / J Profil 25.4

Fit on 3 mm

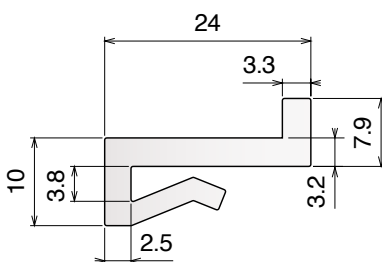
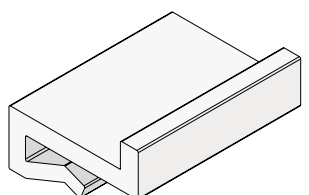

North America STANDARD

Part	Article-Nr.	L	Colour	Availability	Supply
1023	102303C	3 m	white	On request	3 m bars
1023	102303	6 m	white	On request	6 m bars

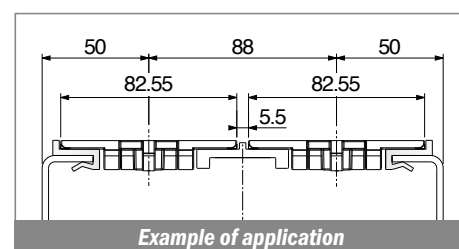

1024 Profilo J-Leg 25.4 / J-Leg Profile 25.4 / J Profil 25.4

Fit on 3 mm

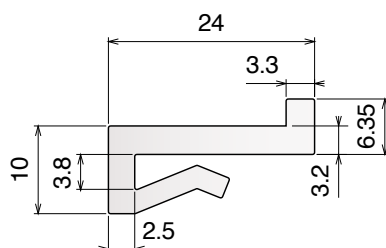
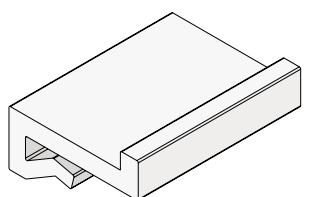

North America STANDARD

Part	Article-Nr.	L	Colour	Availability	Supply
1024	102403C	3 m	white	On request	3 m bars
1024	102403	6 m	white	On request	6 m bars
1024	102403-30	30 m	white	On request	30 m coils
1024	102402	6 m	green	On request	6 m bars

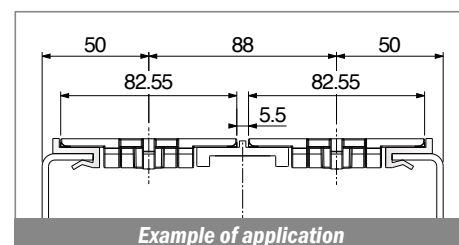

Material:

Polyethylene UHMW-PE with molecular density 5,600,000 g/mol
 Linear expansion coefficient: $1.1 \times 10^{-4} \text{ } ^\circ\text{F}^{-1}$ ($2 \times 10^{-4} \text{ } ^\circ\text{C}^{-1}$)
 Operating temperature: -40 to 176°F (-40 to +80°C)

1025-1026-1027-1028

Guide estruse / Extruded profiles / Extrudiertes profil

1025

Profilo J-Leg 38.1 / J-Leg Profile 38.1 / J Profil 38.1

Fit on 3 mm

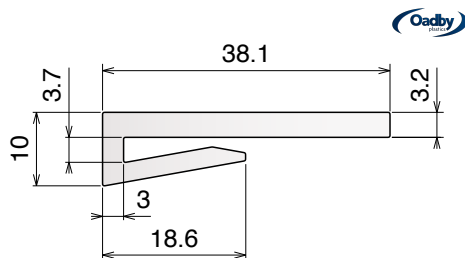
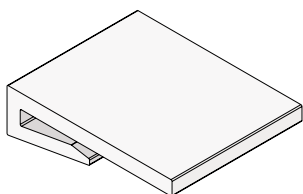

North America STANDARD

Part	Article-Nr.	L	Colour	Availability	Supply
1025	102503C	3 m	white	On request	3 m bars
1025	102503	6 m	white	On request	6 m bars
1025	102503-30	30 m	white	On request	30 m coils

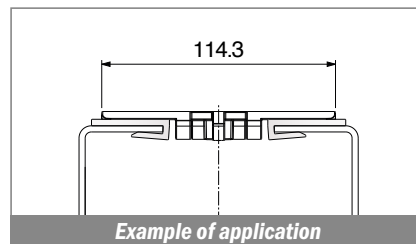

Example of application

1026

Profilo J-Leg 38.1 / J-Leg Profile 38.1 / J Profil 38.1

Fit on 3 mm

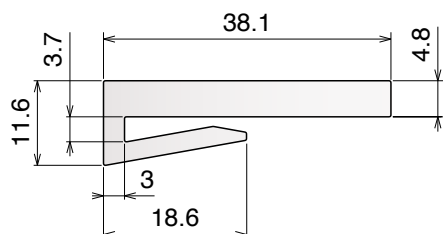
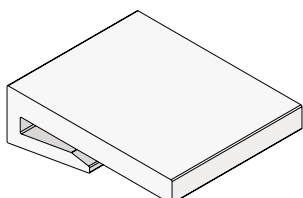

North America STANDARD

Part	Article-Nr.	L	Colour	Availability	Supply
1026	102603C	3 m	white	On request	3 m bars
1026	102603	6 m	white	On request	6 m bars

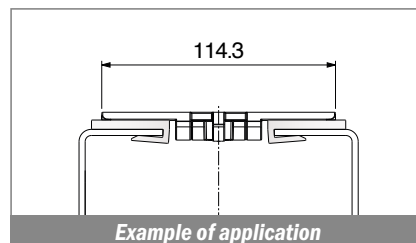

Example of application

1027

Profilo J-Leg 38.1 / J-Leg Profile 38.1 / J Profil 38.1

Fit on 3 mm

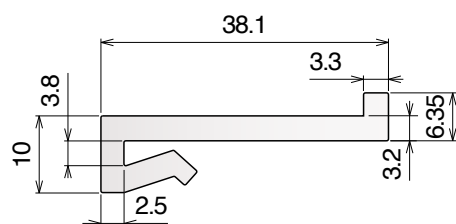
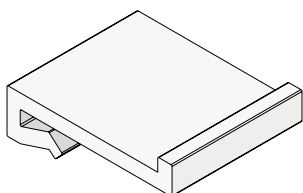

North America STANDARD

Part	Article-Nr.	L	Colour	Availability	Supply
1027	102703C	3 m	white	On request	3 m bars
1027	102703	6 m	white	On request	6 m bars

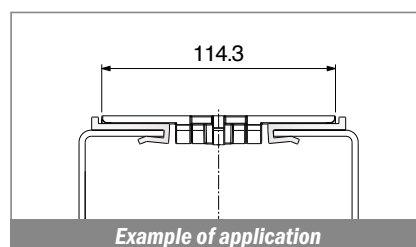

Example of application

1028

Profilo J-Leg 38.1 / J-Leg Profile 38.1 / J Profil 38.1

Fit on 3 mm

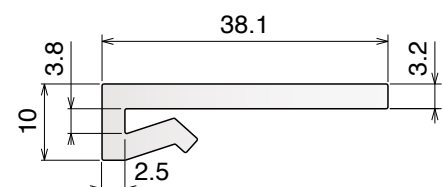
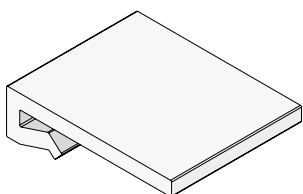

North America STANDARD

Part	Article-Nr.	L	Colour	Availability	Supply
1028	102803C	3 m	white	On request	3 m bars
1028	102803	6 m	white	On request	6 m bars

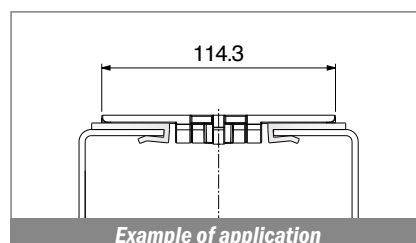

Example of application

1046-1029-1030-1031

Guide estruse / Extruded profiles / Extrudiertes Profil

Material:

Polyethylene UHMW-PE with molecular density 5,600,000 g/mol
 Linear expansion coefficient: $1.1 \times 10^{-4} \text{ } ^\circ\text{F}^{-1}$ ($2 \times 10^{-4} \text{ } ^\circ\text{C}^{-1}$)
 Operating temperature: -40 to 176°F (-40 to +80°C)

1046

Profilo J-Leg 40 / J-Leg Profile 40 / J Profil 40

Delivery: **Easy** **Standard** Fit on 3 mm

North America STANDARD

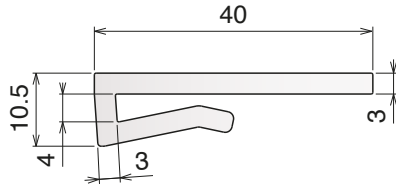
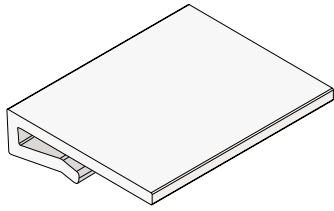

Part	Article-Nr.	L	Colour	Availability	Supply
1046	104602C	3 m	green	On request	3 m bars
1046	104603C	3 m	white	On request	3 m bars
1046	104602-30	30 m	green	On request	30 m coils

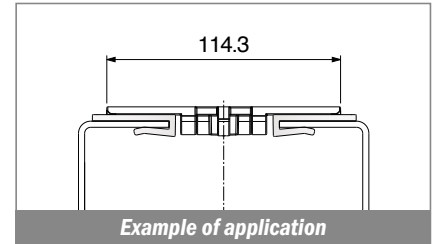

1029

Profilo J-Leg 50.8 / J-Leg Profile 50.8 / J Profil 50.8

Fit on 3 mm

North America STANDARD

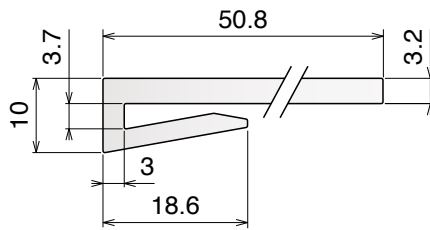
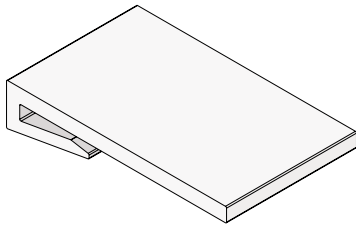

Part	Article-Nr.	L	Colour	Availability	Supply
1029	102903C	3 m	white	On request	3 m bars
1029	102903	6 m	white	On request	6 m bars

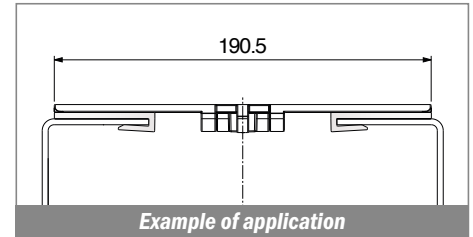

1030

Profilo J-Leg 50.8 / J-Leg Profile 50.8 / J Profil 50.8

Fit on 3 mm

North America STANDARD

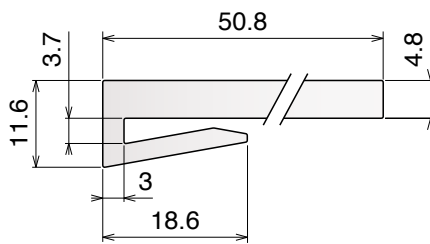
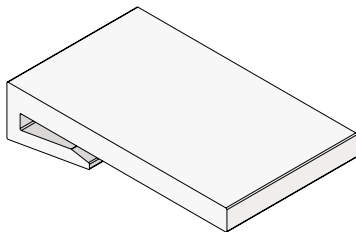

Part	Article-Nr.	L	Colour	Availability	Supply
1030	103003C	3 m	white	On request	3 m bars
1030	103003	6 m	white	On request	6 m bars

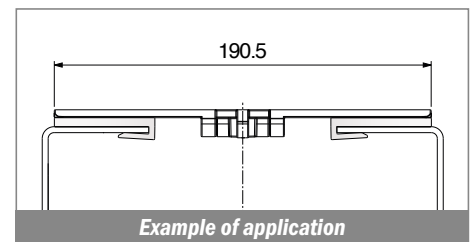

1031

Profilo J-Leg 50.8 / J-Leg Profile 50.8 / J Profil 50.8

Fit on 3 mm

North America STANDARD

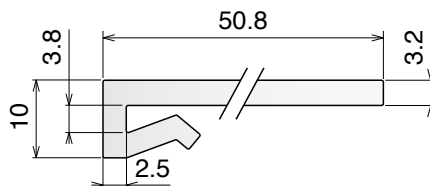
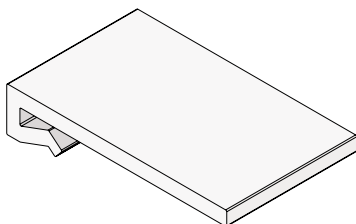

Part	Article-Nr.	L	Colour	Availability	Supply
1031	103103C	3 m	white	On request	3 m bars
1031	103103	6 m	white	On request	6 m bars

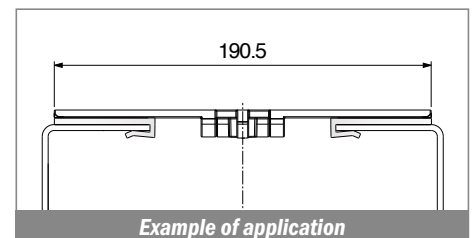

Material:

Polyethylene UHMW-PE with molecular density 5,600,000 g/mol
 Linear expansion coefficient: $1.1 \times 10^{-4} \text{ } ^\circ\text{F}^{-1}$ ($2 \times 10^{-4} \text{ } ^\circ\text{C}^{-1}$)
 Operating temperature: -40 to 176°F (-40 to +80°C)

1032 Profilo J-Leg 50.8 / J-Leg Profile 50.8 / J Profil 50.8

Fit on 3 mm

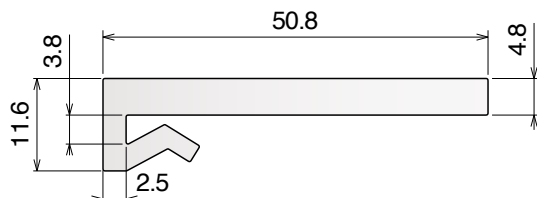
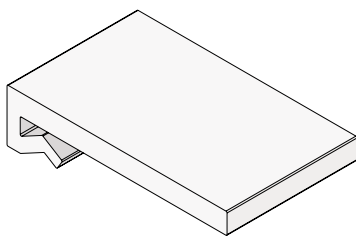

North America STANDARD

Part	Article-Nr.	L	Colour	Availability	Supply
1032	103203C	3 m	white	On request	3 m bars
1032	103203	6 m	white	On request	6 m bars

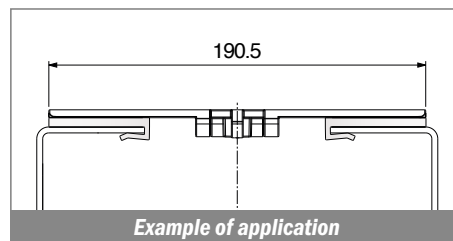

Example of application

1033 Profilo J-Leg 76.2 / J-Leg Profile 76.2 / J Profil 76.2

Fit on 3 mm

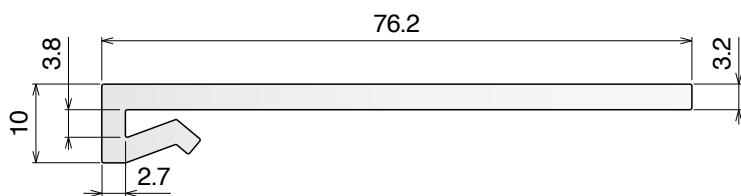
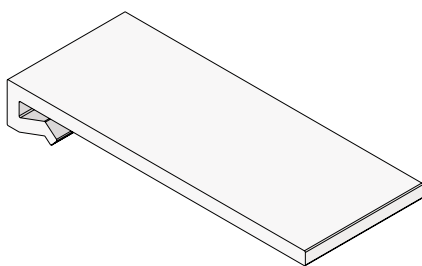

North America STANDARD

Part	Article-Nr.	L	Colour	Availability	Supply
1033	103303C	3 m	white	On request	3 m bars
1033	103303	6 m	white	On request	6 m bars

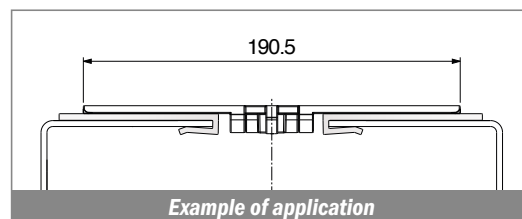

Example of application

1034 Profilo J-Leg 76.2 / J-Leg Profile 76.2 / J Profil 76.2

Fit on 3 mm

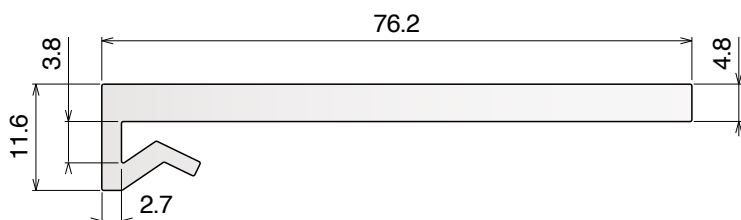
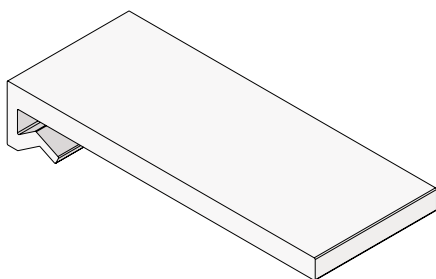

North America STANDARD

Part	Article-Nr.	L	Colour	Availability	Supply
1034	103403C	3 m	white	On request	3 m bars
1034	103403	6 m	white	On request	6 m bars

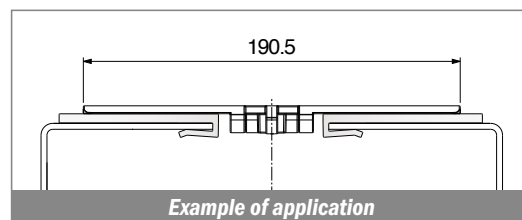

Example of application

1035-105-106

Guide estruse / Extruded profiles / Extrudiertes profil

Material:

Polyethylene UHMW-PE with molecular density 5,600,000 g/mol
 Linear expansion coefficient: $1.1 \times 10^{-4} \text{ } ^\circ\text{F}^{-1}$ ($2 \times 10^{-4} \text{ } ^\circ\text{C}^{-1}$)
 Operating temperature: -40 to 176°F (-40 to +80°C)

1035

Profilo J-Leg 73 / J-Leg Profile 73 / J Profil 73

Fit on 3 mm

North America STANDARD

Part	Article-Nr.	L	Colour	Availability	Supply
1035	103503C	3 m	white	On request	3 m bars
1035	103503	6 m	white	On request	6 m bars

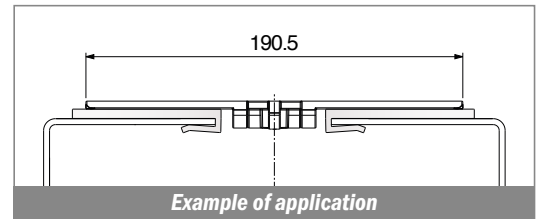
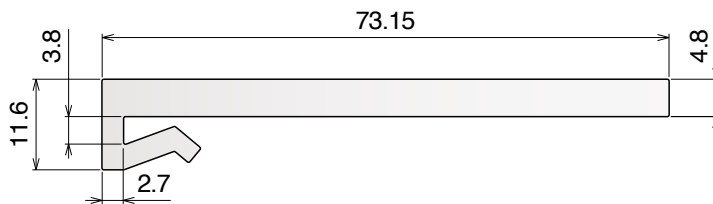
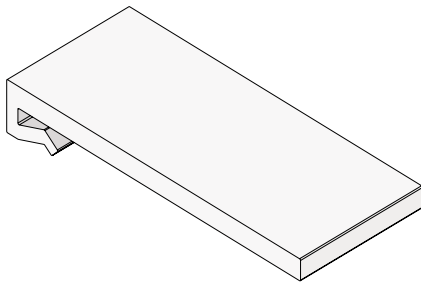

105

Profilo "Z" / Z-Profile / Z-Profil

Delivery: **Easy** **Standard** On request available in white color

Part	Article-Nr.	A	B	Colour	Availability	Supply
105	10501	20	3	black	Stock item	60 m coils
105	10502	20	3	green	Stock item	60 m coils
105	10503	20	5	black	Stock item	60 m coils
105	10504	20	5	green	Stock item	60 m coils
105	10595	25	3	green	Stock item	60 m coils
105	10592	30	3	green	On request	60 m coils
105	10594	30	5	green	On request	60 m coils
105	10596	40	3	green	Stock item	60 m coils
105	10597	50	3	green	On request	60 m coils
105	10505	60	3	black	Stock item	60 m coils
105	10506	60	3	green	Stock item	60 m coils
105	10507	70	3	black	Stock item	60 m coils
105	10508	70	3	green	Stock item	60 m coils
105	10509	100	3	black	On request	60 m coils
105	10510	100	3	green	Stock item	60 m coils

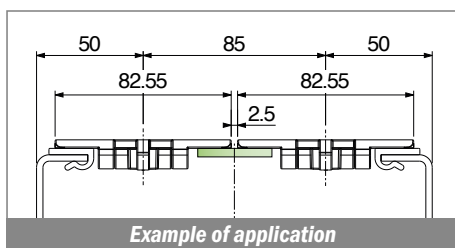
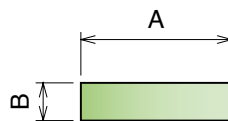
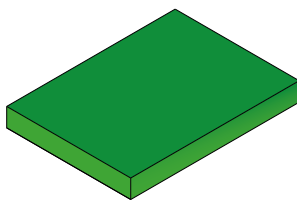

106

Profilo guida catena / Flat profile with nose / Flachprofil mit Nase

On request available in white color

Part	Article-Nr.	Colour	Availability	Supply
106	10601	black	Stock item	60 m coils
106	10602	green	Stock item	60 m coils

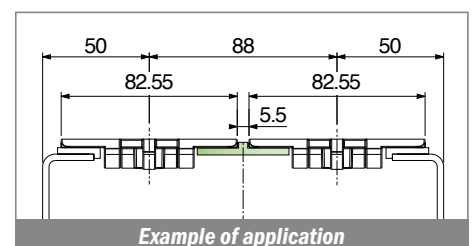
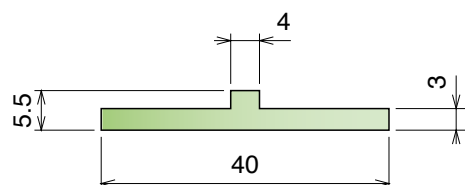
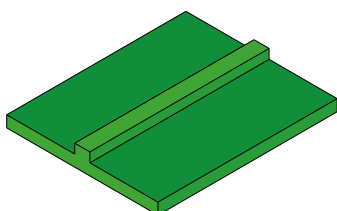

Material:

Polyethylene UHMW-PE with molecular density 5,600,000 g/mol
 Linear expansion coefficient: $1.1 \times 10^{-4} \text{ } ^\circ\text{F}^{-1}$ ($2 \times 10^{-4} \text{ } ^\circ\text{C}^{-1}$)
 Operating temperature: -40 to 176°F (-40 to +80°C)

107 Profilo guida catena / Wear strip / Rückführleiste

Delivery: **Easy** **Standard** On request available in white color

Part	Article-Nr.	Colour	Availability	Supply
107	10701	black	Stock item	60 m coils
107	10702	green	Stock item	60 m coils

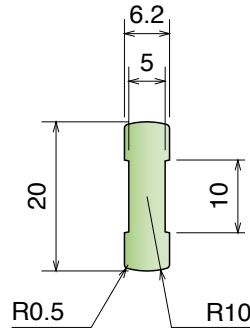
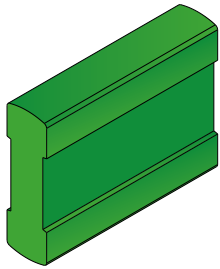

Supports Available:
PART 230-231
 Pag 358

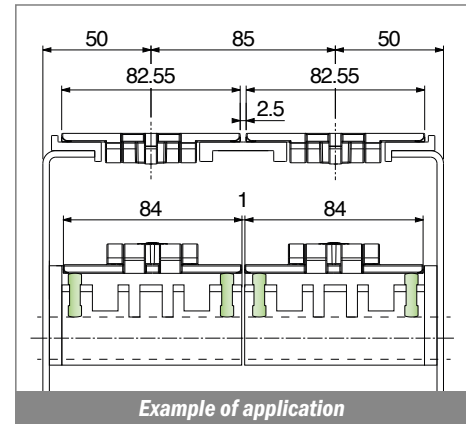

108 Profilo T / T-profile / T-Profil

Delivery: **Easy** **Standard** On request available in white color

Part	Article-Nr.	L	Colour	Availability	Supply
108	10801C	3 m	black	Stock item	3 m bars
108	10801	6 m	black	On request	6 m bars
108	10802C	3 m	green	Stock item	3 m bars
108	10802	6 m	green	On request	6 m bars

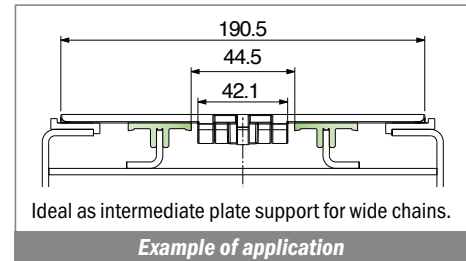
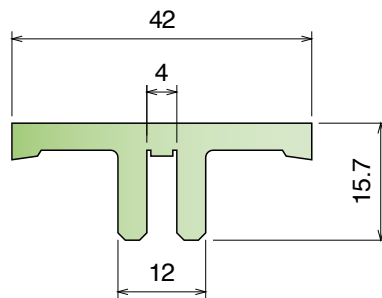
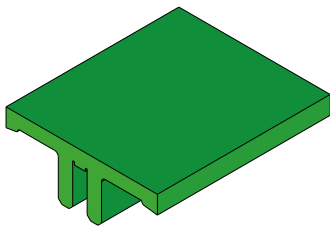

109 Profilo clip-on guida catena / Flat clip-on wear strip / U-Profil Clip-on

Delivery: **Easy** **Standard**

Part	Article-Nr.	L	Colour	Availability	Supply
109	10901C	3 m	black	Stock item	3 m bars
109	10901	6 m	black	On request	6 m bars
109	10902C	3 m	green	Stock item	3 m bars
109	10902	6 m	green	On request	6 m bars
109	10903C	3 m	white	Stock item	3 m bars
109	10903	6 m	white	Stock item	6 m bars
109	10901BC	3 m	BluLub	Stock item	3 m bars
109	10901B	6 m	BluLub	On request	6 m bars
109	10901B-30	30 m	BluLub	On request	30 m coils

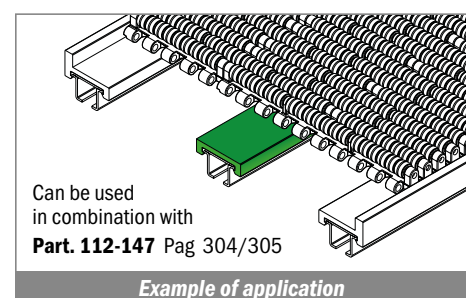
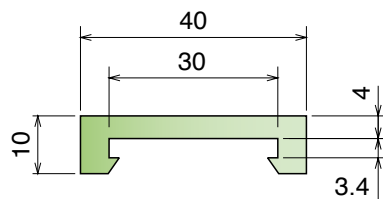
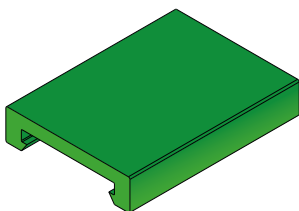

Can be used
 in combination with
Part. 112-147 Pag 304/305

Material:

Polyethylene UHMW-PE with molecular density 5,600,000 g/mol
 Linear expansion coefficient: $1.1 \times 10^{-4} \text{ } ^\circ\text{F}^{-1}$ ($2 \times 10^{-4} \text{ } ^\circ\text{C}^{-1}$)
 Operating temperature: -40 to 176°F (-40 to +80°C)

110 Profilo clip-on guida catena con bordo / Flat clip-on wear strip with nose / U-Profil Clip-on mit Nase

On request available in white color

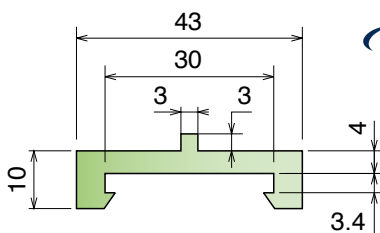
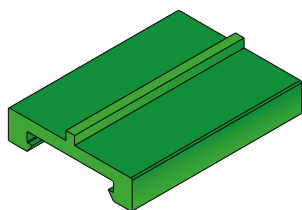

Part	Article-Nr.	L	Colour	Availability	Supply
110	11001C	3 m	black	Stock item	3 m bars
110	11001	6 m	black	On request	6 m bars
110	11002C	3 m	green	Stock item	3 m bars
110	11002	6 m	green	On request	6 m bars

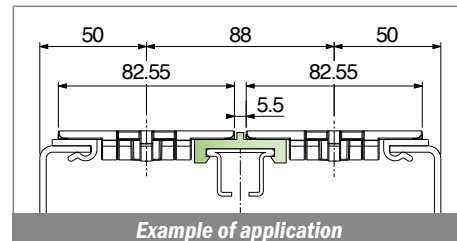

Example of application

156 Profilo clip-on guida tappeto / Clip-on wear strip for belt / Clip-on m. Seitenführung

Delivery: **Easy** **Standard** On request available in white color

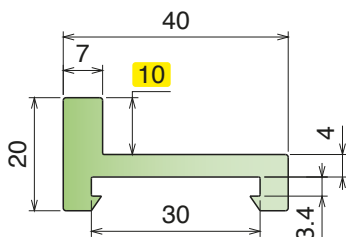
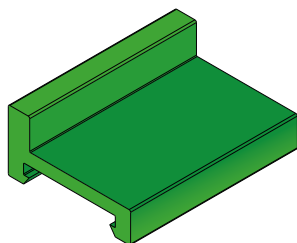

Part	Article-Nr.	L	Colour	Availability	Supply
156	15601C	3 m	black	Stock item	3 m bars
156	15601	6 m	black	On request	6 m bars
156	15602C	3 m	green	Stock item	3 m bars
156	15602	6 m	green	On request	6 m bars

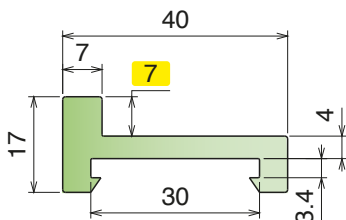
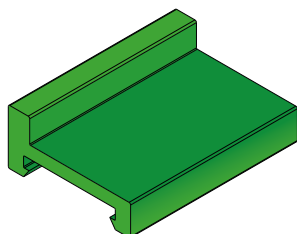

Part	Article-Nr.	L	Colour	Availability	Supply
156	15699C	3 m	green	On request	3 m bars

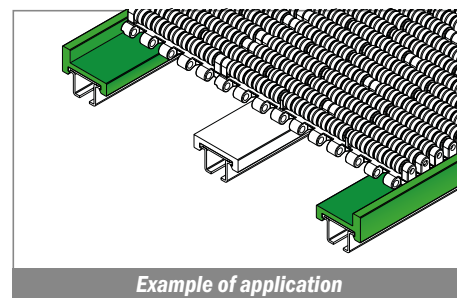

Example of application

112 Profilo / Profile / Profil

Delivery: **Easy** **Standard**

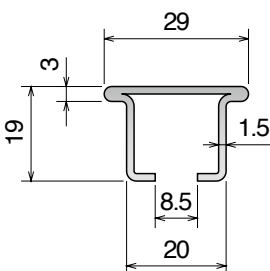
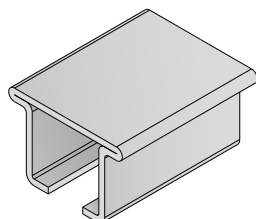

Part	Article-Nr.	L	Material	Availability	Supply
112	11201C	3 m	AISI 304	Stock item	3 m bars
112	11201	6 m	AISI 304	On request	6 m bars
112	11202C	3 m	AISI 430	Stock item	3 m bars
112	11202	6 m	AISI 430	On request	6 m bars

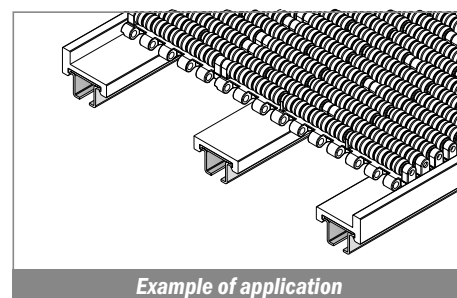

Example of application

Material:

Polyethylene UHMW-PE with molecular density 5,600,000 g/mol
 Linear expansion coefficient: $1.1 \times 10^{-4} \text{ } ^\circ\text{F}^{-1}$ ($2 \times 10^{-4} \text{ } ^\circ\text{C}^{-1}$)
 Operating temperature: -40 to 176°F (-40 to +80°C)

147 Profilo in alluminio / Aluminum profile / Aluminium-Profil

Delivery: **Easy** **Standard**

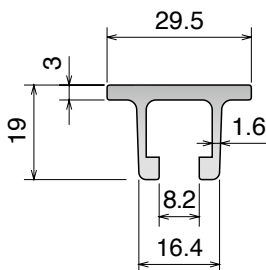
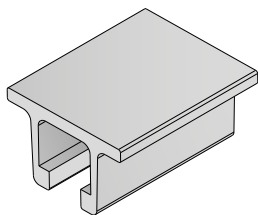

Part	Article-Nr.	L	Material	Availability	Supply
147	14701C	3 m	Aluminium	Stock item	3 m bars
147	14701	6 m	Aluminium	On request	6 m bars

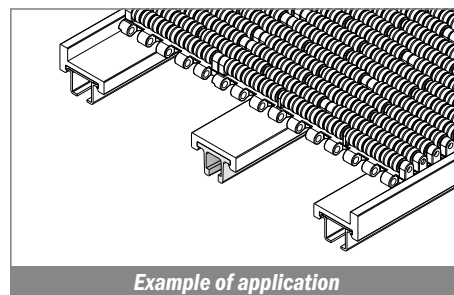

133 Profilo assemblato clip-on / Profile assembled clip-on / Profile montiert clip-on

Delivery: **Easy** **Standard** On request available in white color

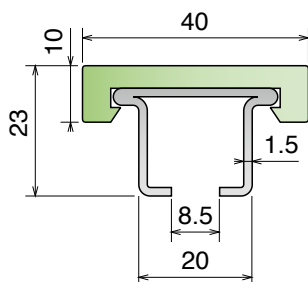
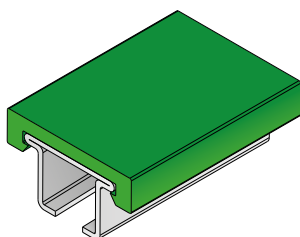

Part	Article-Nr.	L	Material	Colour	Availability	Supply
133	13301C	3 m	AISI 304	green	Stock item	3 m bars
133	13301	6 m	AISI 304	green	On request	6 m bars
133	13302C	3 m	AISI 430	green	Stock item	3 m bars
133	13302	6 m	AISI 430	green	On request	6 m bars
133	13303C	3 m	AISI 304	black	Stock item	3 m bars
133	13303	6 m	AISI 304	black	On request	6 m bars
133	13304C	3 m	AISI 430	black	Stock item	3 m bars
133	13304	6 m	AISI 430	black	On request	6 m bars
133	13305BC	3 m	AISI 304	BluLub	Stock item	3 m bars
133	13305B	6 m	AISI 304	BluLub	On request	6 m bars
133	13306BC	3 m	AISI 430	BluLub	Stock item	3 m bars
133	13306B	6 m	AISI 430	BluLub	On request	6 m bars

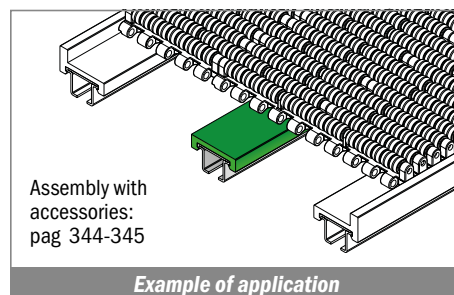

148 Profilo assemblato clip-on / Profile assembled clip-on / Profile montiert clip-on

Delivery: **Easy** **Standard**

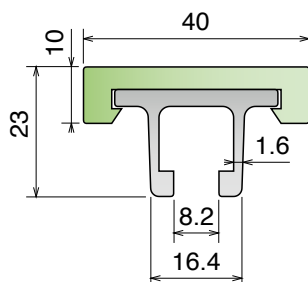
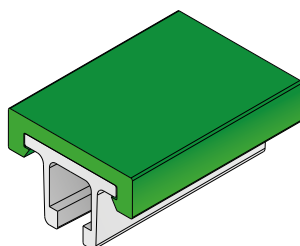

Part	Article-Nr.	L	Material	Colour	Availability	Supply
148	14801C	3 m	Aluminium	green	Stock item	3 m bars
148	14801	6 m	Aluminium	green	On request	6 m bars
148	14801BC	3 m	Aluminium	BluLub	Stock item	3 m bars
148	14801B	6 m	Aluminium	BluLub	On request	6 m bars
148	14802C	3 m	Aluminium	black	Stock item	3 m bars
148	14802	6 m	Aluminium	black	On request	6 m bars
148	14803C	3 m	Aluminium	white	Stock item	3 m bars

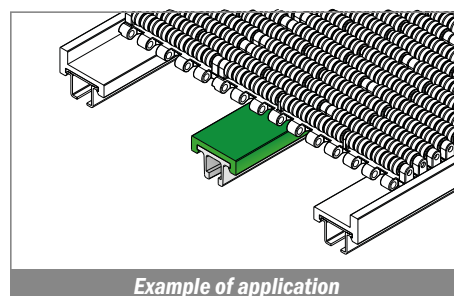

Material:

Polyethylene UHMW-PE with molecular density 5,600,000 g/mol
 Linear expansion coefficient: $1.1 \times 10^{-4} \text{ } ^\circ\text{F}^{-1}$ ($2 \times 10^{-4} \text{ } ^\circ\text{C}^{-1}$)
 Operating temperature: -40 to 176°F (-40 to +80°C)

157

Profilo guida tappeto assemblato / Wear strip assembled for belt / Gleitleiste für mattenketten kpl montiert

Delivery: **Easy** Standard On request available in white color

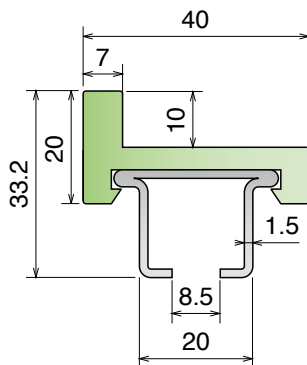
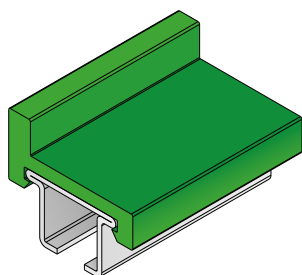

Part	Article-Nr.	L	Material	Colour	Availability	Supply
157	15701C	3 m	AISI 304	green	Stock item	3 m bars
157	15701	6 m	AISI 304	green	On request	6 m bars
157	15702C	3 m	AISI 430	green	Stock item	3 m bars
157	15702	6 m	AISI 430	green	On request	6 m bars

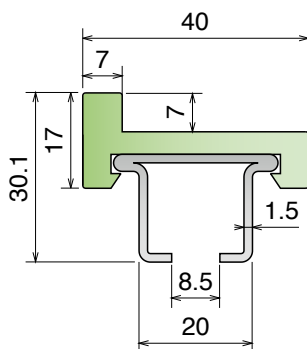
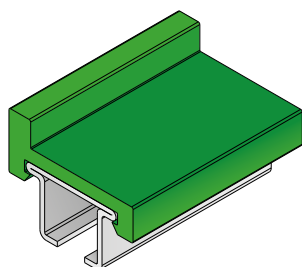
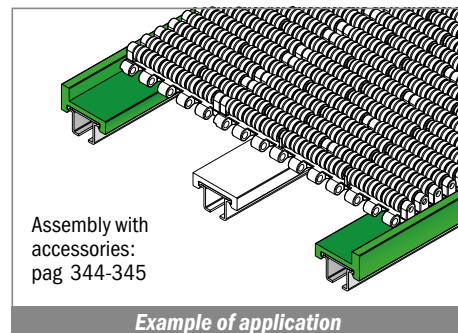

Part	Article-Nr.	L	Material	Colour	Availability	Supply
157	15799C	3 m	AISI 304	green	On request	3 m bars

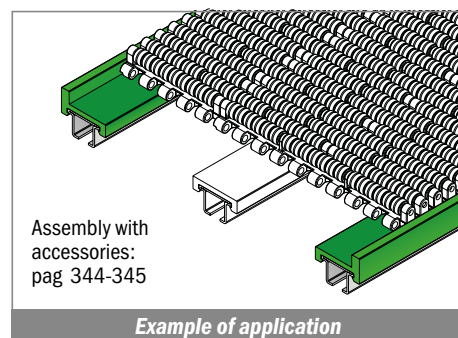

118

Profilo Delta / D-Profile / D-Profil

Delivery: **Easy** Standard

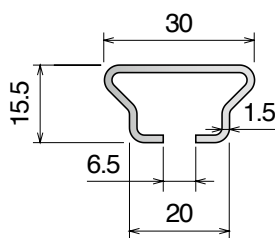
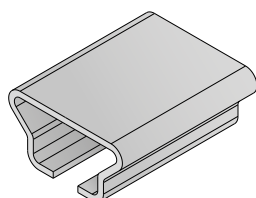

Part	Article-Nr.	L	Material	Availability	Supply
118	11801C	3 m	AISI 304	Stock item	3 m bars
118	11801	6 m	AISI 304	On request	6 m bars
118	11802C	3 m	AISI 430	Stock item	3 m bars
118	11802	6 m	AISI 430	On request	6 m bars

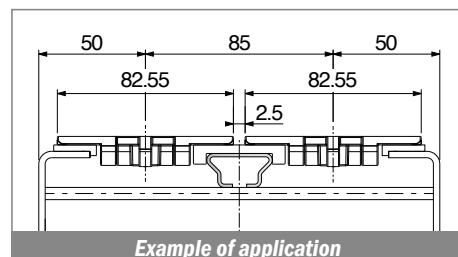

Material:

Polyethylene UHMW-PE with molecular density 5,600,000 g/mol
 Linear expansion coefficient: $1.1 \times 10^{-4} \text{ } ^\circ\text{F}^{-1}$ ($2 \times 10^{-4} \text{ } ^\circ\text{C}^{-1}$)
 Operating temperature: -40 to 176°F (-40 to +80°C)

149 Profilo ad "U" con bordo / U-profile with nose / U-Profil mit Nase

On request available in white color | Coils available

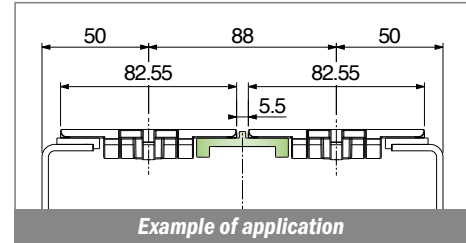
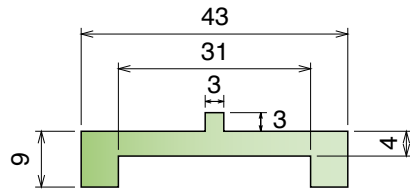
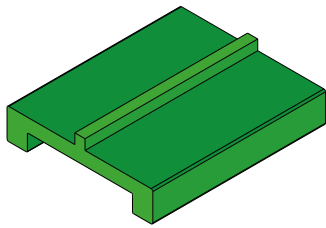

Part	Article-Nr.	L	Colour	Availability	Supply
149	14950C	3 m	black	Stock item	3 m bars
149	14950	6 m	black	On request	6 m bars
149	14952C	3 m	green	Stock item	3 m bars
149	14952	6 m	green	On request	6 m bars

177 Profilo ad "U" / U-profile / U-Profil

Delivery: **Easy** **Standard** On request available in white color

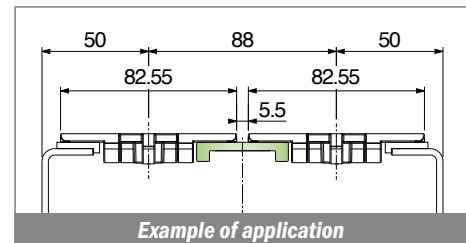
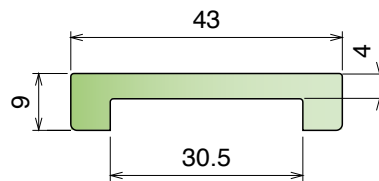
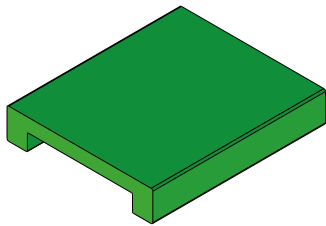

Part	Article-Nr.	L	Colour	Availability	Supply
177	17701C	3 m	black	Stock item	3 m bars
177	17701	6 m	black	On request	6 m bars
177	17702C	3 m	green	Stock item	3 m bars
177	17702	6 m	green	On request	6 m bars
177	17701BC	3 m	BluLub	Stock item	3 m bars
177	17701B	6 m	BluLub	On request	6 m bars
177	17702-30	30 m	green	On request	30 m coils

1059 Profilo ad "U" / U-profile / U-Profil

Delivery: **Easy** **Standard** On request available in white color
 Coils available

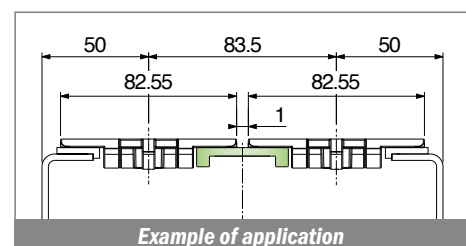
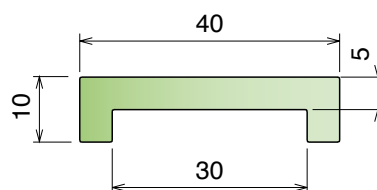
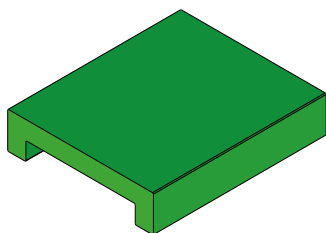

Part	Article-Nr.	L	Colour	Availability	Supply
1059	105901C	3 m	black	Stock item	3 m bars
1059	105901	6 m	black	On request	6 m bars
1059	105902C	3 m	green	Stock item	3 m bars
1059	105902	6 m	green	On request	6 m bars
1059	105901BC	3 m	BluLub	Stock item	3 m bars
1059	105901B	6 m	BluLub	On request	6 m bars

Material:

Polyethylene UHMW-PE with molecular density 5,600,000 g/mol
 Linear expansion coefficient: $1.1 \times 10^{-4} \text{ } ^\circ\text{F}^{-1}$ ($2 \times 10^{-4} \text{ } ^\circ\text{C}^{-1}$)
 Operating temperature: -40 to 176°F (-40 to +80°C)

178 Profilo ad "U" / U-profile / U-Profil

Delivery: **Easy** **Standard** On request available in white color | Coils available

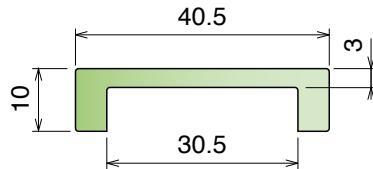
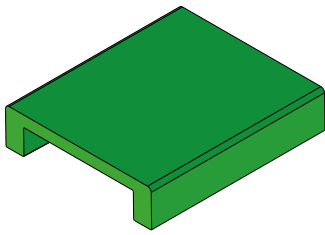

Part	Article-Nr.	L	Colour	Availability	Supply
178	17801C	3 m	black	Stock item	3 m bars
178	17801	6 m	black	On request	6 m bars
178	17802C	3 m	green	Stock item	3 m bars
178	17802	6 m	green	On request	6 m bars
178	17801BC	3 m	BluLub	Stock item	3 m bars
178	17801B	6 m	BluLub	On request	6 m bars

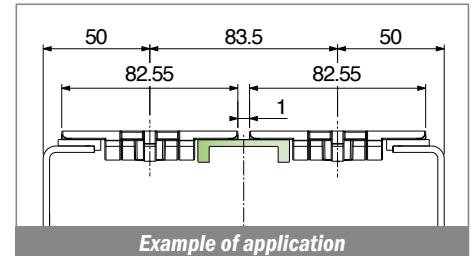

111 Profilo ad "U" / U-profile / U-Profil

Delivery: **Easy** **Standard** On request available in white color

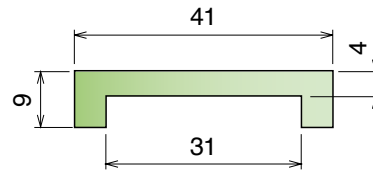
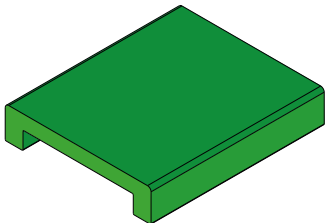

Part	Article-Nr.	L	Colour	Availability	Supply
111	11101C	3 m	black	Stock item	3 m bars
111	11101	6 m	black	On request	6 m bars
111	11102C	3 m	green	Stock item	3 m bars
111	11102	6 m	green	On request	6 m bars
111	11101-60	60 m	black	On request	60 m coils
111	11102-60	60 m	green	On request	60 m coils
111	11101BC	3 m	BluLub	Stock item	3 m bars
111	11101B	6 m	BluLub	On request	6 m bars

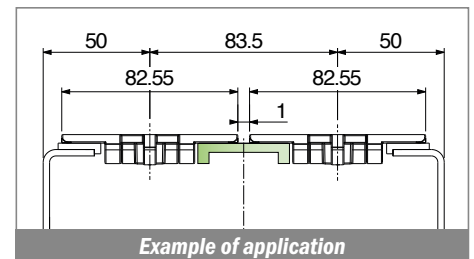

1060 Profilo ad "U" / U-profile / U-Profil

Delivery: **Easy** **Standard** On request available in white color

Coils available

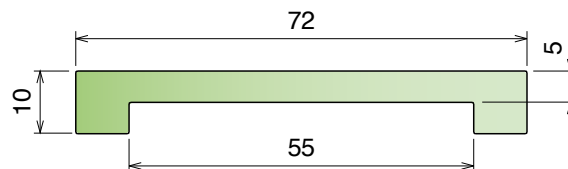
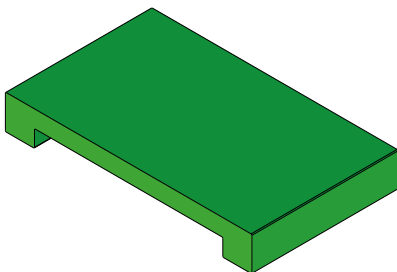

Part	Article-Nr.	L	Colour	Availability	Supply
1060	106001C	3 m	black	Stock item	3 m bars
1060	106001	6 m	black	On request	6 m bars
1060	106002C	3 m	green	Stock item	3 m bars
1060	106002	6 m	green	On request	6 m bars

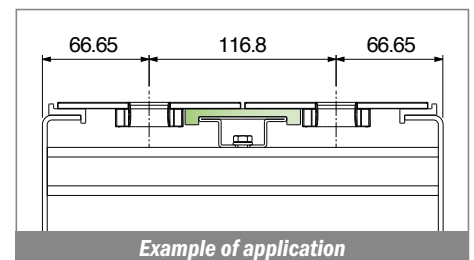

Material:

Polyethylene UHMW-PE with molecular density 5,600,000 g/mol
 Linear expansion coefficient: $1.1 \times 10^{-4} \text{ } ^\circ\text{F}^{-1}$ ($2 \times 10^{-4} \text{ } ^\circ\text{C}^{-1}$)
 Operating temperature: -40 to 176°F (-40 to +80°C)

199-U-Profile

Guide estruse / Extruded profiles / Extrudiertes profil

199 Profilo ad "U" / U-profile / U-Profil

On request available in white color | Coils available

Part	Article-Nr.	L	Colour	Availability	Supply
199	19976	6 m	white	On request	6 m bars

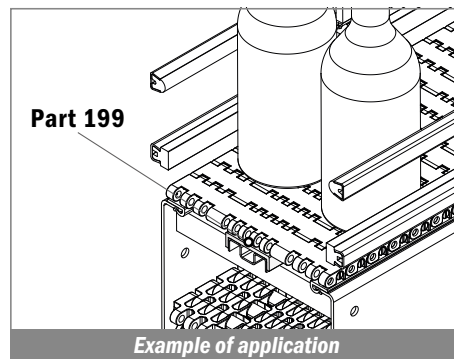
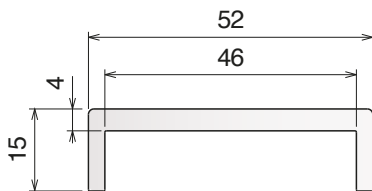
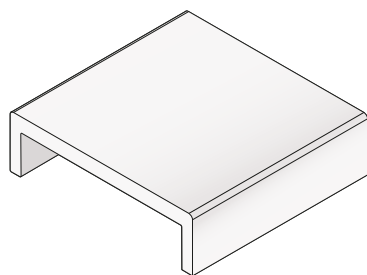

U-Profile Profilo ad "U" 42 mm / U-profile 42 mm / U-Profil 42 mm

On request available in white color

Part	Article-Nr.	L	Colour	Availability	Supply
199	19944B-30	30 m	BluLub	On request	30 m bars

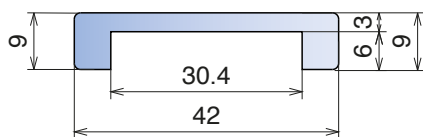
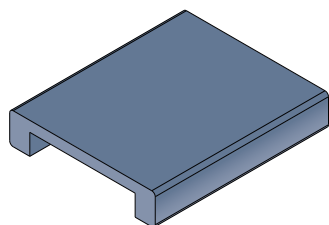

Staggered version

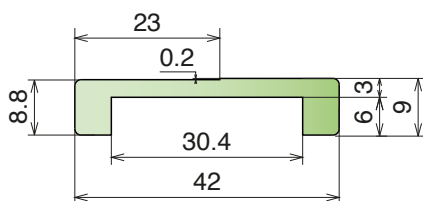
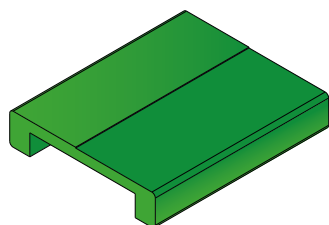

Part	Article-Nr.	L	Colour	Availability	Supply
199	19945-30	30 m	black	Stock item	30 m bars
199	19945B-30	30 m	BluLub	Stock item	30 m bars
199	19946-30	30 m	green	Stock item	30 m bars

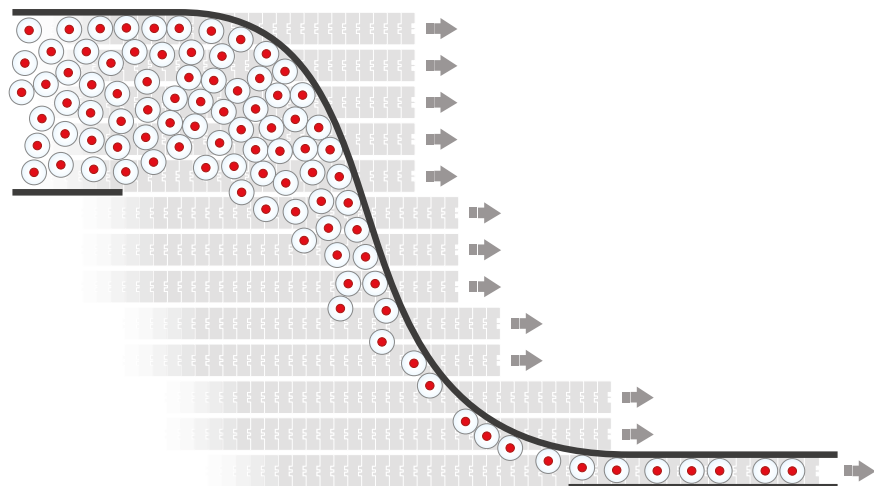
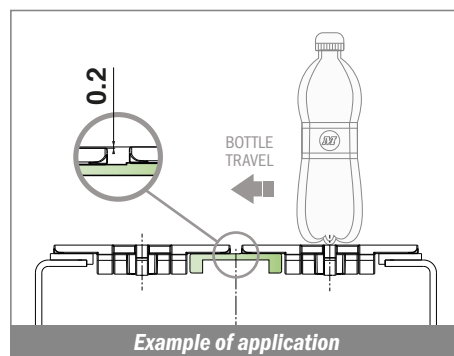

Material:

Polyethylene UHMW-PE with molecular density 5,600,000 g/mol
 Linear expansion coefficient: $1.1 \times 10^{-4} \text{ } ^\circ\text{F}^{-1}$ ($2 \times 10^{-4} \text{ } ^\circ\text{C}^{-1}$)
 Operating temperature: -40 to 176°F (-40 to +80°C)

180 Copri profilo / Bar cover / Abdeckprofil

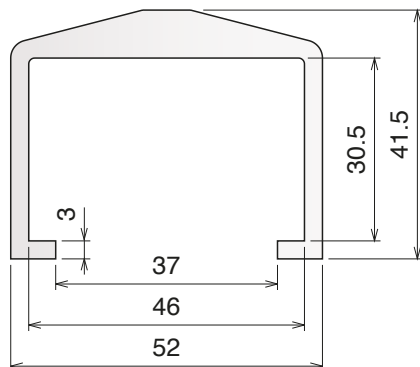
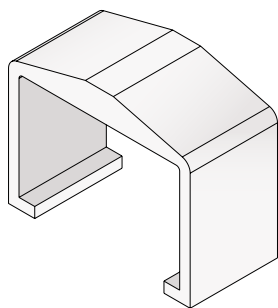

Part	Article-Nr.	L	Colour	Availability	Supply
180	18003C	3 m	white	Stock item	3 m bars
180	18003	6 m	white	On request	6 m bars

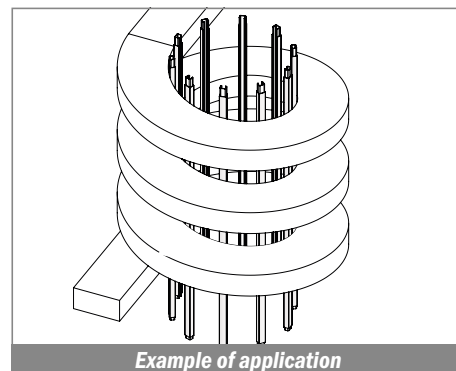

181 Copri profilo 25.4 x 25.4 / Bar cover 25.4 x 25.4 / Abdeckprofil 25.4 x 25.4

Fit on 25.4 x 25.4 mm

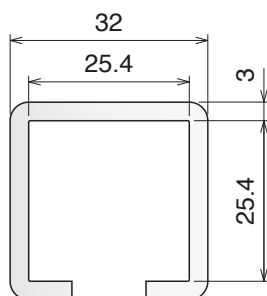
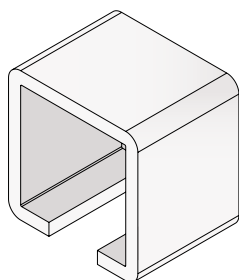

Part	Article-Nr.	L	Colour	Availability	Supply
181	18103C	3 m	white	Stock item	3 m bars
181	18103	6 m	white	On request	6 m bars

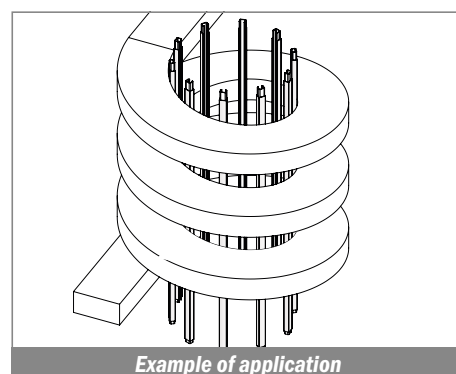

1052 Copri profilo 38.1 x 50.8 / Bar cover 38.1 x 50.8 / Abdeckprofil 38.1 x 50.8

Fit on 38.1 x 50.8 mm

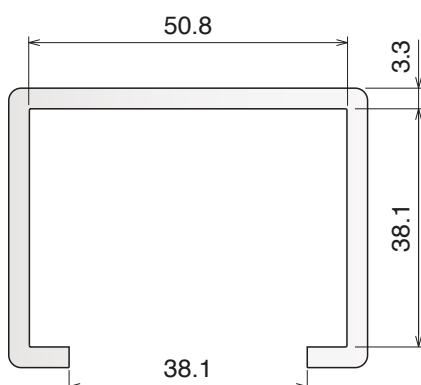
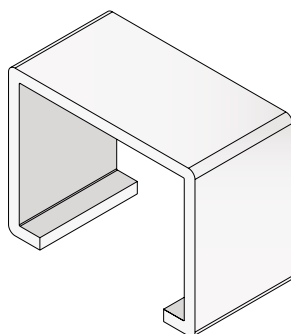

Part	Article-Nr.	L	Colour	Availability	Supply
1052	105203C	3 m	white	Stock item	3 m bars
1052	105203	6 m	white	On request	6 m bars

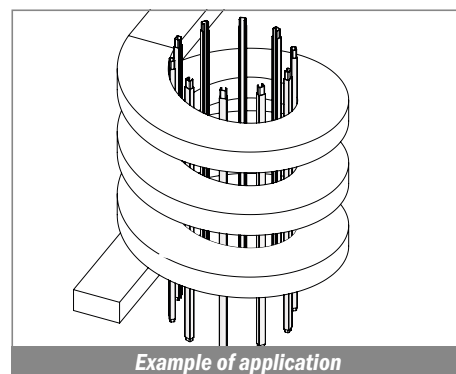

Material:

Polyethylene UHMW-PE with molecular density 5,600,000 g/mol
 Linear expansion coefficient: $1.1 \times 10^{-4} \text{ } ^\circ\text{F}^{-1}$ ($2 \times 10^{-4} \text{ } ^\circ\text{C}^{-1}$)
 Operating temperature: -40 to 176°F (-40 to +80°C)

1000-1001-1002-1003

Guide estruse / Extruded profiles / Extrudiertes profil

1000 Copri profilo 1.5 mm / Bar cap 1.5 mm / Abdeckprofil 1.5 mm

Fit on 1.5 mm

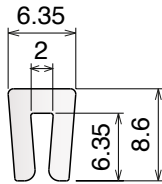
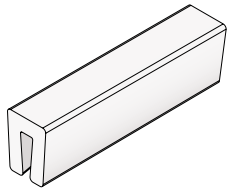

Part	Article-Nr.	L	Colour	Availability	Supply
1000	100003-30	30 m	white	On request	30 m coils

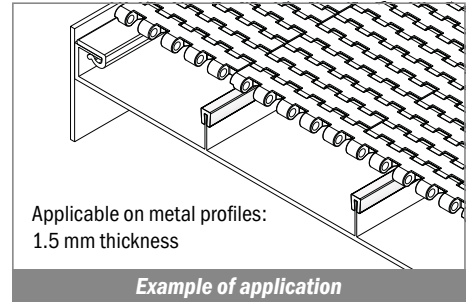

1001 Copri profilo 1.5 mm / Bar cap 1.5 mm / Abdeckprofil 1.5 mm

Fit on 1.5 mm

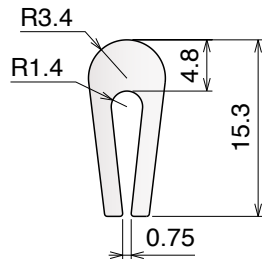
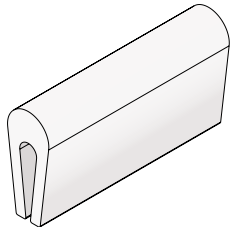

Part	Article-Nr.	L	Colour	Availability	Supply
1001	100103-30	30 m	white	On request	30 m coils

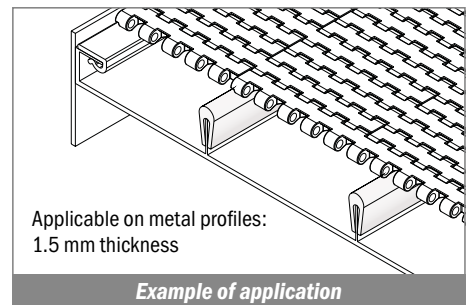

1002 Copri profilo 3 mm / Bar cap 3 mm / Abdeckprofil 3 mm

Fit on 3 mm

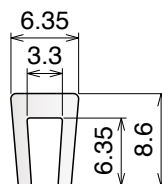
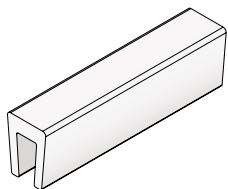

Part	Article-Nr.	L	Colour	Availability	Supply
1002	100203-30	30 m	white	On request	30 m coils

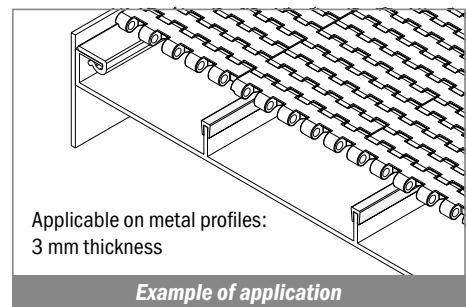

1003 Copri profilo 3 mm / Bar cap 3 mm / Abdeckprofil 3 mm

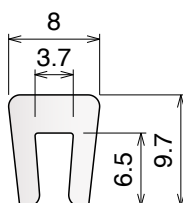
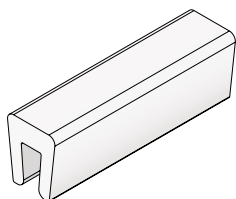
Delivery: **Easy** **Standard** Fit on 3 mm

Part	Article-Nr.	L	Colour	Availability	Supply
1003	100303-30	30 m	white	On request	30 m coils

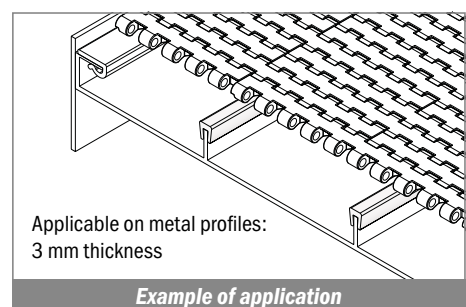

Material:

Polyethylene UHMW-PE with molecular density 5,600,000 g/mol
 Linear expansion coefficient: $1.1 \times 10^{-4} \text{ } ^\circ\text{F}^{-1}$ ($2 \times 10^{-4} \text{ } ^\circ\text{C}^{-1}$)
 Operating temperature: -40 to 176°F (-40 to +80°C)

1004 Copri profilo 3 mm / Bar cap 3 mm / Abdeckprofil 3 mm

Delivery: **Easy** **Standard** Fit on 3 mm

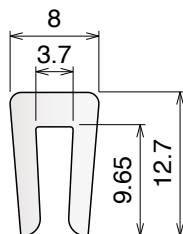
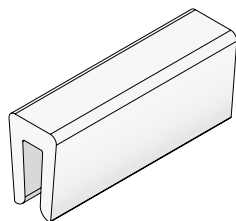

Part	Article-Nr.	L	Colour	Availability	Supply
1004	100403-30	30 m	white	On request	30 m coils

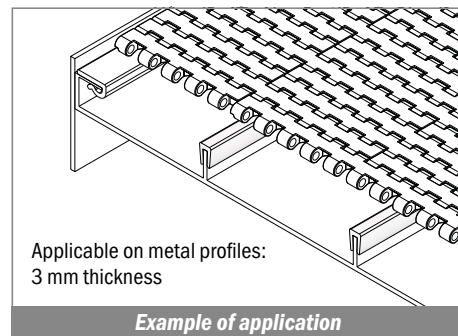

1006 Copri profilo 5 mm / Bar cap 5 mm / Abdeckprofil 5 mm

Fit on 5 mm

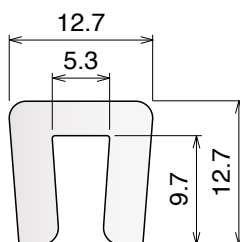
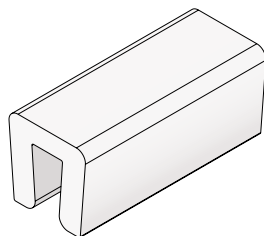

Part	Article-Nr.	L	Colour	Availability	Supply
1006	100603-30	30 m	white	On request	30 m coils

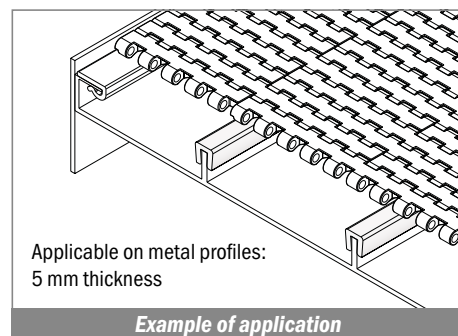

153 Copri profilo 5 mm / Bar cap 5 mm / Abdeckprofil 5 mm

Delivery: **Easy** **Standard** Fit on 4/5 mm

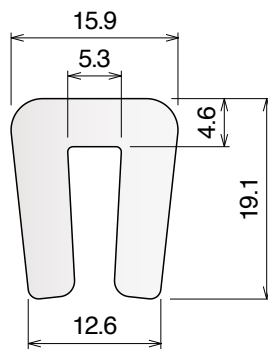
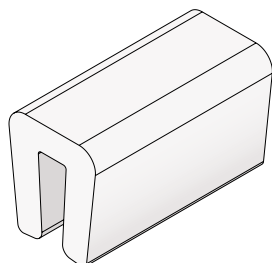

Part	Article-Nr.	L	Colour	Availability	Supply
153	15302	6 m	green	On request	30 m coils
153	15302C	3 m	green	On request	3 m bars
153	15303	6 m	white	On request	6 m bars
153	15303-30	30 m	white	Stock item	30 m coils
153	15300	6 m	BluLub	Stock item	6 m bars
153	15300-30	30 m	BluLub	Stock item	30 m coils
153	15300C	3 m	BluLub	On request	3 m bars

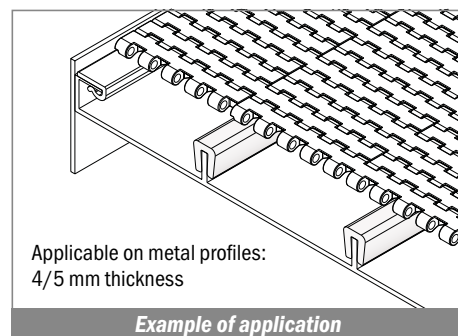

Material:

Polyethylene UHMW-PE with molecular density 5,600,000 g/mol
 Linear expansion coefficient: $1.1 \times 10^{-4} \text{ } ^\circ\text{F}^{-1}$ ($2 \times 10^{-4} \text{ } ^\circ\text{C}^{-1}$)
 Operating temperature: -40 to 176°F (-40 to +80°C)

1007 Copri profilo 5 mm / Bar cap 5 mm / Abdeckprofil 5 mm

Fit on 5 mm

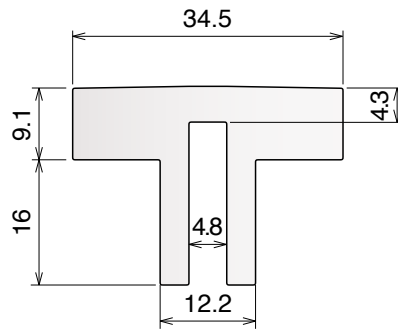
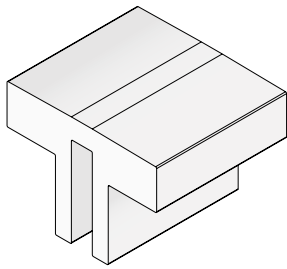

Part	Article-Nr.	L	Colour	Availability	Supply
1007	100703C	6 m	white	On request	6 m bars
1007	100703B	6 m	BluLub	On request	6 m bars

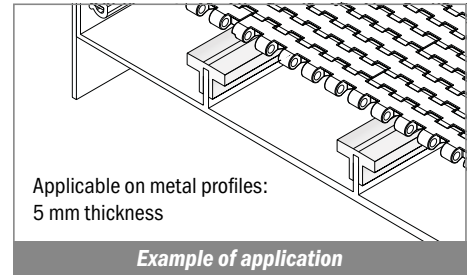

1008 Copri profilo 5 mm / Bar cap 5 mm / Abdeckprofil 5 mm

Fit on 5 mm

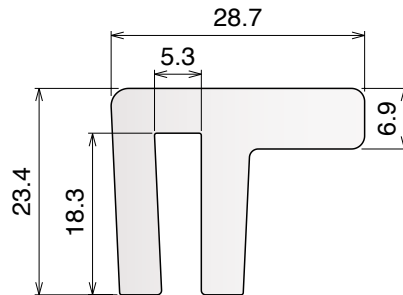
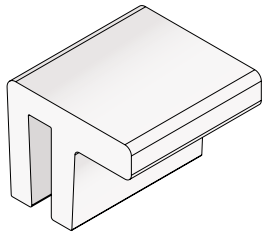

Part	Article-Nr.	L	Colour	Availability	Supply
1008	100803	6 m	white	On request	6 m bars
1008	100803B	6 m	BluLub	On request	6 m bars
1008	100803C	3 m	white	On request	3 m bars

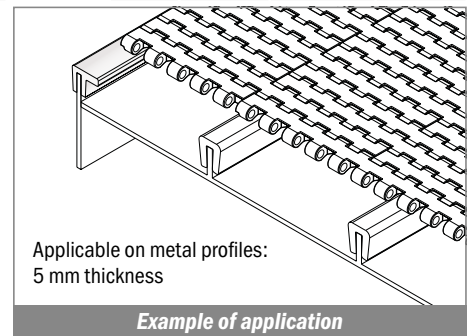

1009 Copri profilo 6 mm / Bar cap 6 mm / Abdeckprofil 6 mm

Delivery: **Easy** Standard Fit on 6 mm

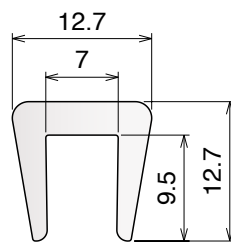
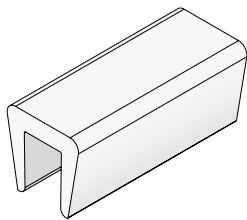

Part	Article-Nr.	L	Colour	Availability	Supply
1009	100903-30	30 m	white	On request	30 m coils

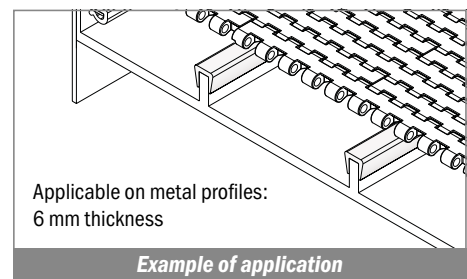

1010 Copri profilo 6 mm / Bar cap 6 mm / Abdeckprofil 6 mm

Fit on 6 mm

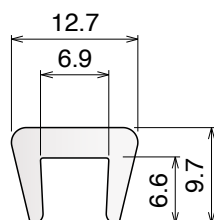
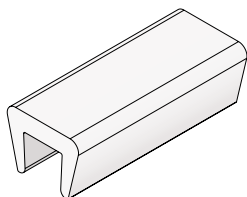

Part	Article-Nr.	L	Colour	Availability	Supply
1010	101003-30	30 m	white	On request	30 m coils

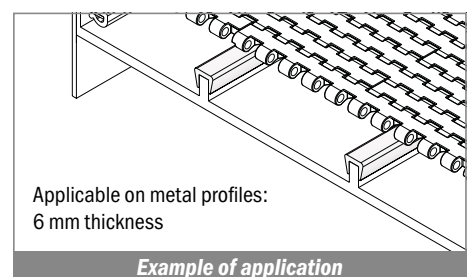

1011-1012-1013-1040

Guide estruse / Extruded profiles / Extrudiertes profil

Material:

Polyethylene UHMW-PE with molecular density 5,600,000 g/mol
 Linear expansion coefficient: $1.1 \times 10^{-4} \text{ } ^\circ\text{F}^{-1}$ ($2 \times 10^{-4} \text{ } ^\circ\text{C}^{-1}$)
 Operating temperature: -40 to 176°F (-40 to +80°C)

1011 Copri profilo 10 mm / Bar cap 10 mm / Abdeckprofil 10 mm

Fit on 10 mm

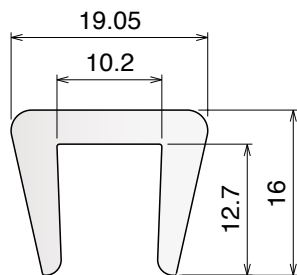
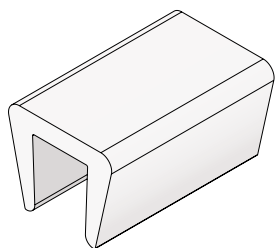

Part	Article-Nr.	L	Colour	Availability	Supply
1011	101103-30	30 m	white	On request	30 m coils
1011	101103-60	60 m	white	On request	60 m coils

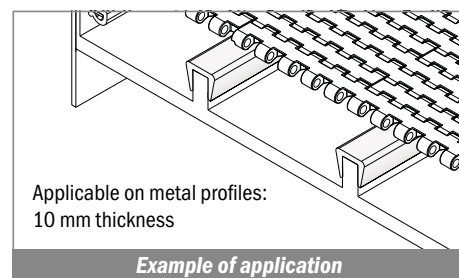

1012 Copri profilo 12-13 mm / Bar cap 12-13 mm / Abdeckprofil 12-13 mm

Fit on 12/13 mm

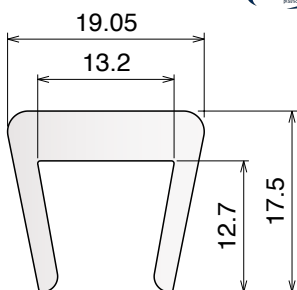
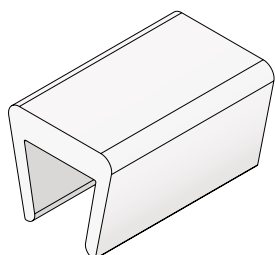

Part	Article-Nr.	L	Colour	Availability	Supply
1012	101203-30	30 m	white	On request	30 m coils

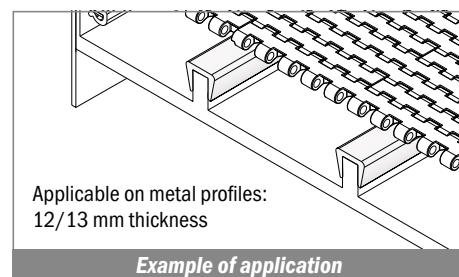

1013 Copri profilo 10 mm / Bar cap 10 mm / Abdeckprofil 10 mm

Fit on 10 mm

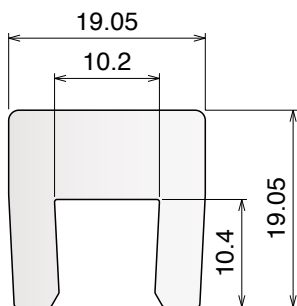
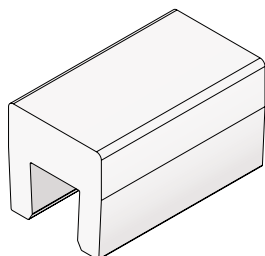

Part	Article-Nr.	L	Colour	Availability	Supply
1013	101303	6 m	white	On request	6 m coils

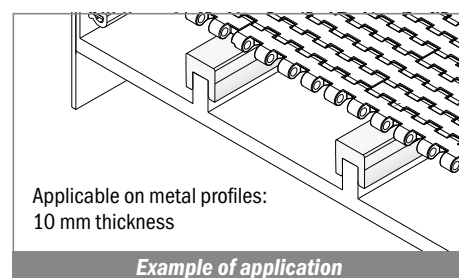

1040 Guide tappeto / Belt side guide / Seitentükuung für matterkette

Fit on 3 mm

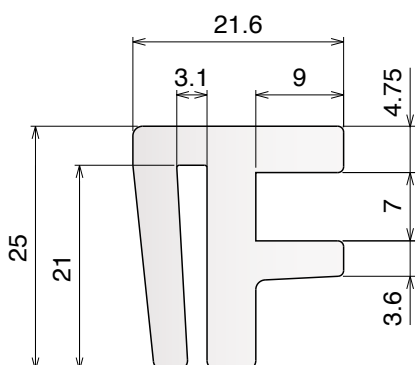
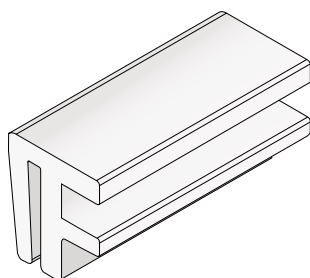

Part	Article-Nr.	L	Colour	Availability	Supply
1040	104003C	3 m	white	On request	3 m bars
1040	104003	6 m	white	On request	6 m bars

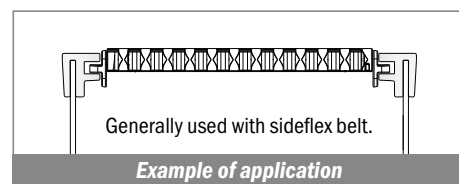

Material:

Polyethylene UHMW-PE with molecular density 5,600,000 g/mol
 Linear expansion coefficient: $1.1 \times 10^{-4} \text{ } ^\circ\text{F}^{-1}$ ($2 \times 10^{-4} \text{ } ^\circ\text{C}^{-1}$)
 Operating temperature: -40 to 176°F (-40 to +80°C)

119 Guida conica tonda / Guide rail round / konische Führung rund

Delivery: **Easy** **Standard** Supply: 3/6 m bars

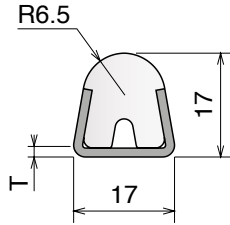
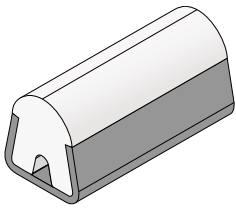

Part	Article-Nr.	L	T	Metal profile	Colour	Availability	Type
119	11963	3 m	1.9	AISI 304	white	Stock item	
119	11967	6 m	1.9	AISI 304	white	On request	
119	11963B	3 m	1.9	AISI 304	BluLub	On request	
119	11967B	6 m	1.9	AISI 304	BluLub	On request	
119	11901C	3 m	1.5	AISI 304	white	Stock item	
119	11901	6 m	1.5	AISI 304	white	Stock item	
119	11901BC	3 m	1.5	AISI 304	BluLub	Stock item	
119	11901B	6 m	1.5	AISI 304	BluLub	Stock item	

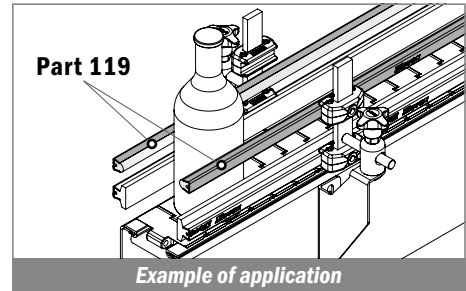

120 Guida conica semitonda / Guide rail modified / konische Führung halbrund

Delivery: **Easy** **Standard** Supply: 3/6 m bars

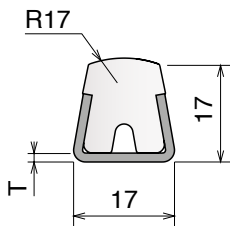
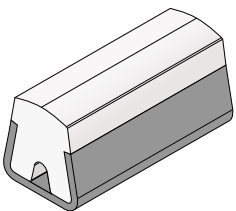

Part	Article-Nr.	L	T	Metal profile	Colour	Availability	Type
120	12063	3 m	1.9	AISI 304	white	Stock item	
120	12067	6 m	1.9	AISI 304	white	On request	
120	12063B	3 m	1.9	AISI 304	BluLub	On request	
120	12067B	6 m	1.9	AISI 304	BluLub	On request	
120	12001C	3 m	1.5	AISI 304	white	Stock item	
120	12001	6 m	1.5	AISI 304	white	Stock item	
120	12001BC	3 m	1.5	AISI 304	BluLub	Stock item	
120	12001B	6 m	1.5	AISI 304	BluLub	Stock item	

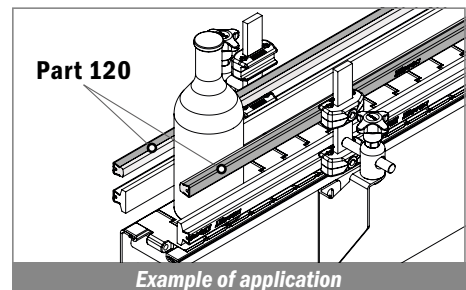

121 Guida conica piatta / Guide rail flat / konische Führung flach

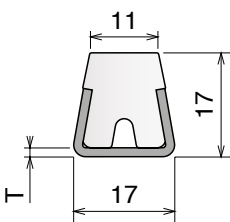
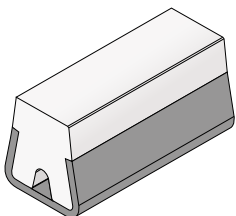

Delivery: **Easy** **Standard** Supply: 3/6 m bars

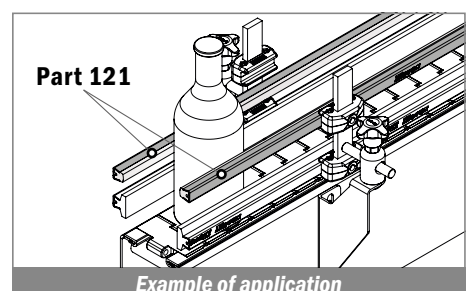

Part	Article-Nr.	L	T	Metal profile	Colour	Availability	Type
121	12163	3 m	1.9	AISI 304	white	On request	
121	12167	6 m	1.9	AISI 304	white	On request	
121	12163B	3 m	1.9	AISI 304	BluLub	On request	
121	12167B	6 m	1.9	AISI 304	BluLub	On request	
121	12101C	3 m	1.5	AISI 304	white	Stock item	
121	12101	6 m	1.5	AISI 304	white	Stock item	
121	12101BC	3 m	1.5	AISI 304	BluLub	Stock item	
121	12101B	6 m	1.5	AISI 304	BluLub	Stock item	



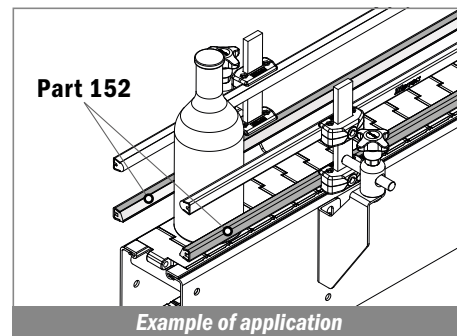
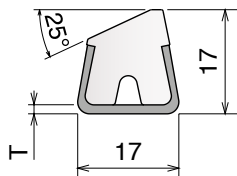
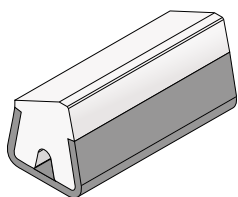

152 Guida conica 25° / Guide rail 25° / konische Führung 25°

Delivery:	Easy	Standard	Supply: 3 m bars	Part	Article-Nr.	L	T	Metal profile	Colour	Availability	Type
				152	15263	3 m	1.9	AISI 304	white	On request	
				152	15201C	3 m	1.5	AISI 304	white	Stock item	



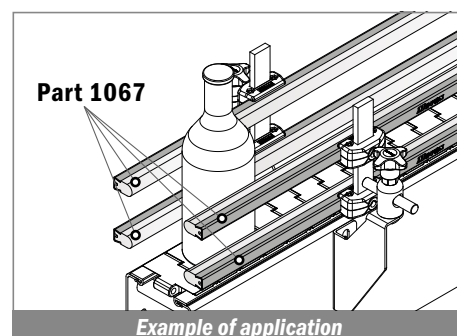
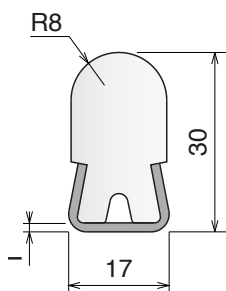
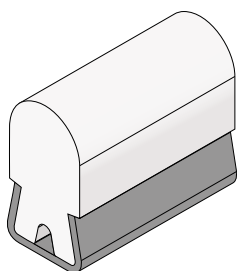

1067 Guida conica H 18 / Guide rail H 18 / konische Führung H 18

Supply: 3 m bars	Part	Article-Nr.	L	T	Metal profile	Colour	Availability	Type
	1067	106763	3 m	1.9	AISI 304	white	On request	
	1067	106701C	3 m	1.5	AISI 304	white	On request	



122 Guida conica profilo a T 25,4 mm / Guide rail T-shape 25,4 mm / konische Führung flach (T) 25,4 mm

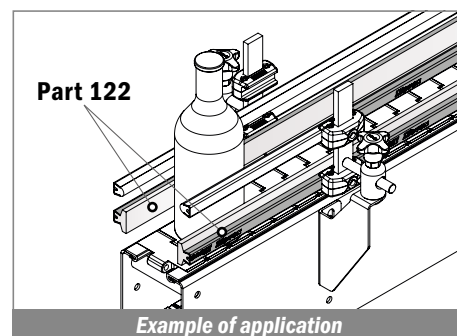
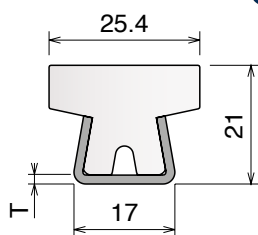
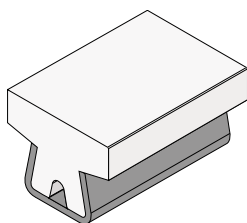

Delivery:	Easy	Standard	Supply: 3 m bars	Part	Article-Nr.	L	T	Metal profile	Colour	Availability	Type
				122	12263	3 m	1.9	AISI 304	white	Stock item	
				122	12201C	3 m	1.5	AISI 304	white	Stock item	



Material:
Metal profile: Stainless steel
Plastic profile: UHMW-PE

123 Guida conica profilo a T 31,75 mm / Guide rail T-shape 31,75 mm / konische Führung flach (T) 31,75 mm

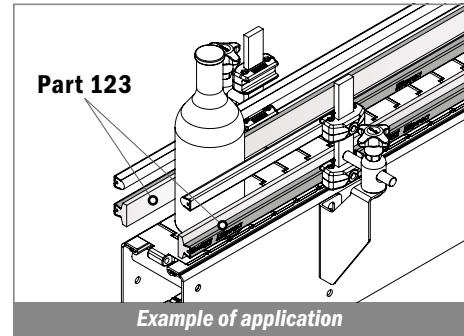
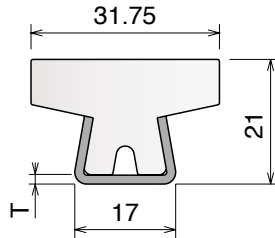
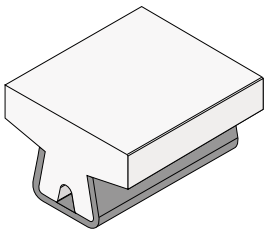

Delivery: **Easy** **Standard** Supply: 3 m bars

Part	Article-Nr.	L	T	Metal profile	Colour	Availability	Type
123	12363	3 m	1.9	AISI 304	white	Stock item	
123	12301C	3 m	1.5	AISI 304	white	Stock item	



140 Guida conica profilo a T 25,4 mm / Guide rail T-shape 25,4 mm / konische Führung flach (T) 25,4 mm

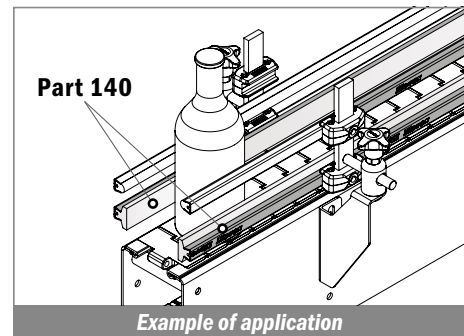
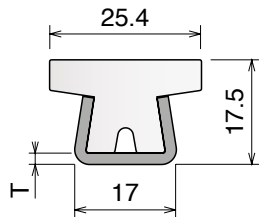
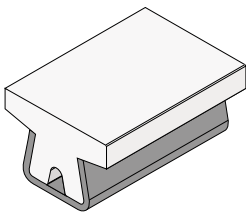

Delivery: **Easy** **Standard** Supply: 3 m bars

Part	Article-Nr.	L	T	Metal profile	Colour	Availability	Type
140	14063	3 m	1.9	AISI 304	white	Stock item	
140	14001C	3 m	1.5	AISI 304	white	Stock item	



146 Guida conica profilo a T 31,75 mm / Guide rail T-shape 31,75 mm / konische Führung flach (T) 31,75 mm

Delivery: **Easy** **Standard** Supply: 3 m bars

Part	Article-Nr.	L	T	Metal profile	Colour	Availability	Type
146	14663	3 m	1.9	AISI 304	white	On request	
146	14601C	3 m	1.5	AISI 304	white	Stock item	

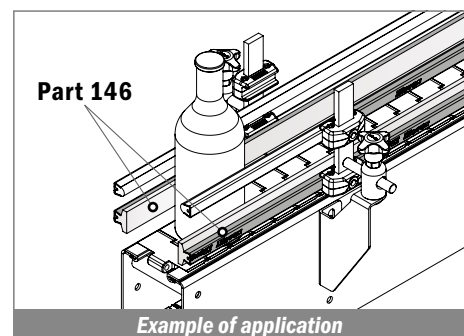
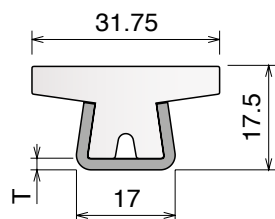
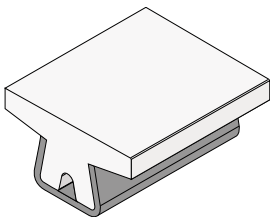

124-143-141

Guide estruse / Extruded profiles / Extrudiertes profil

Material:
Metal profile: Stainless steel
Plastic profile: UHMW-PE

124

Guida conica profilo a T 40 mm / Guide rail T-shape 40 mm / konische Führung flach (T) 40 mm

Delivery: **Easy** Standard Supply: 3 m bars

Part	Article-Nr.	L	T	Metal profile	Colour	Availability	Type
124	12463	3 m	1.9	AISI 304	white	On request	
124	12401C	3 m	1.5	AISI 304	white	Stock item	

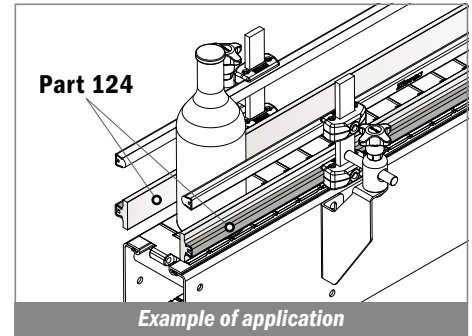
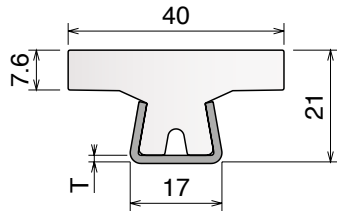
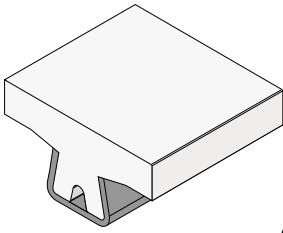

143

Guida conica profilo a "T" 19,05 mm / Guide rail T-shape 19,05 mm / konische Führung flach (T) 19,05 mm

Delivery: **Easy** Standard Supply: 3 m bars

Part	Article-Nr.	L	T	Metal profile	Colour	Availability	Type
143	14363	3 m	1.9	AISI 304	white	On request	
143	14301C	3 m	1.5	AISI 304	white	Stock item	

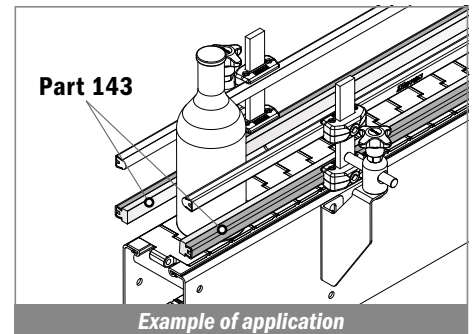
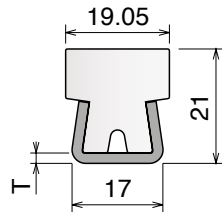
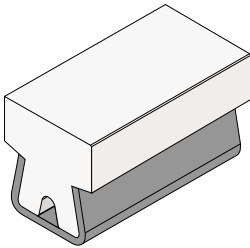

141

Guida conica profilo a "T" 57,15 mm / Guide rail T-shape 57,15 mm / konische Führung flach (T) 57,15 mm

Delivery: **Easy** Standard Supply: 3 m bars

Part	Article-Nr.	L	T	Metal profile	Colour	Availability	Type
141	14163	3 m	1.9	AISI 304	white	On request	
141	14101C	3 m	1.5	AISI 304	white	Stock item	

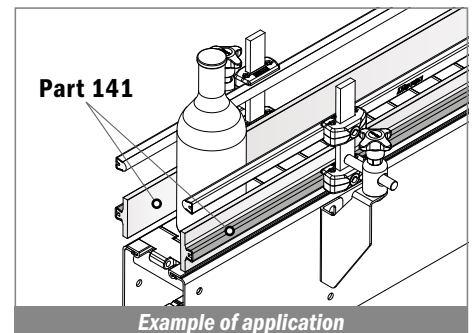
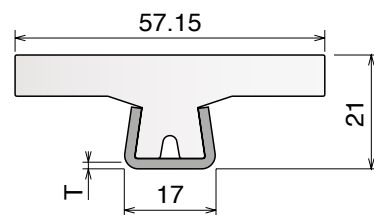
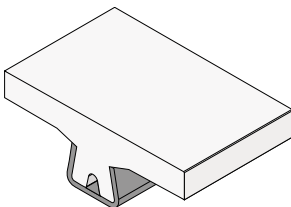

Material:
Metal profile: Stainless steel
Plastic profile: UHMW-PE

142 Guida conica profilo a "T" 43,2 mm / Guide rail T-shape 43,2 mm / konische Führung flach (T) 43,2 mm

Supply: 3 m bars

Part	Article-Nr.	L	T	Metal profile	Colour	Availability	Type
142	14263	3 m	1.9	AISI 304	white	On request	
142	14201C	3 m	1.5	AISI 304	white	Stock item	

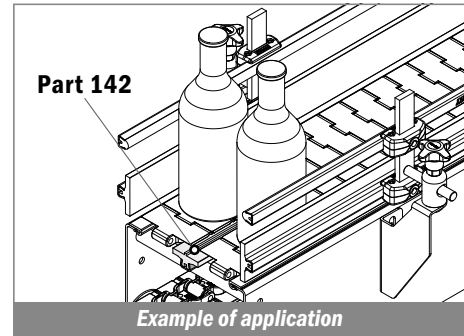
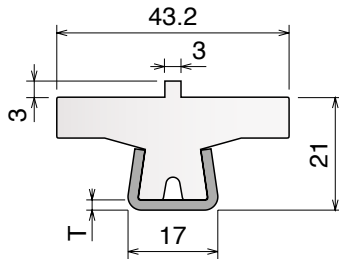
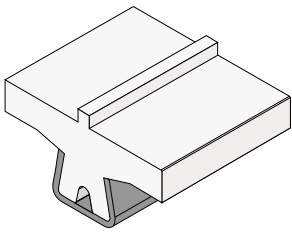

125 Guida conica profilo a "L" 31,75 mm / Guide rail L-shape 31,75 mm / konische Führung flach (L) 31,75 mm

Delivery: **Easy** Standard Supply: 3 m bars

Part	Article-Nr.	L	T	Metal profile	Colour	Availability	Type
125	12563	3 m	1.9	AISI 304	white	Stock item	
125	12501C	3 m	1.5	AISI 304	white	Stock item	

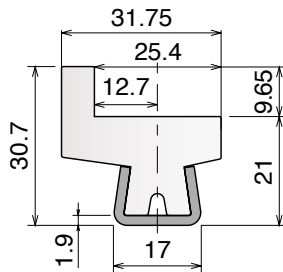
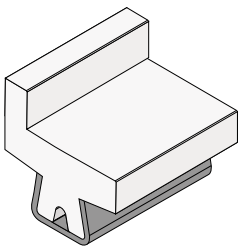

PART 12563

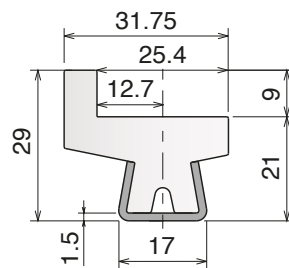

PART 12501C

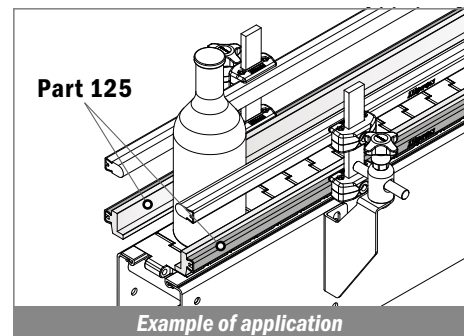

144 Guida conica profilo a "L" 31,75 mm / Guide rail L-shape 31,75 mm / konische Führung flach (L) 31,75 mm

Delivery: **Easy** Standard Supply: 3 m bars

Part	Article-Nr.	L	T	Metal profile	Colour	Availability	Type
144	14463	3 m	1.9	AISI 304	white	Stock item	
144	14401C	3 m	1.5	AISI 304	white	Stock item	

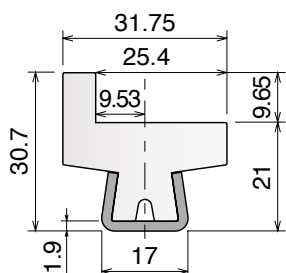
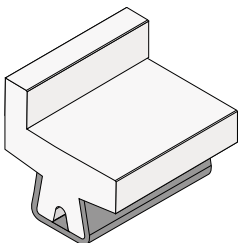

PART 14463

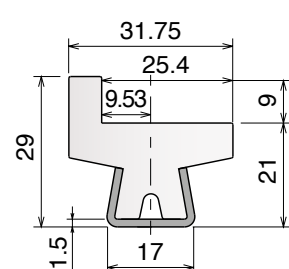

PART 14401C

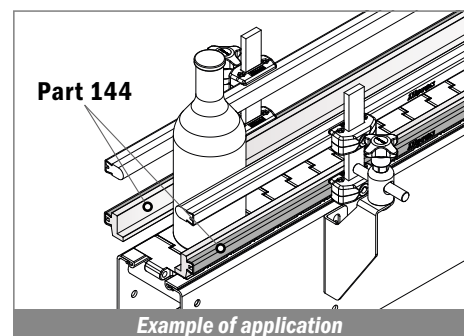

184 Guida conica per catena / Guide rail for chain / konische Führung

Supply: 3 m bars

Part	Article-Nr.	L	T	Metal profile	Colour	Availability	Type
184	18463	3 m	1.9	AISI 304	white	On request	
184	18401C	3 m	1.5	AISI 304	white	Stock item	

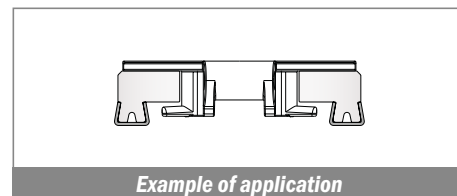
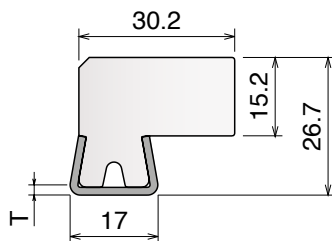
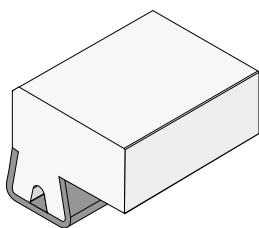

191 Guida conica per catena / Guide rail for chain / konische Führung

Supply: 3 m bars

Part	Article-Nr.	L	T	Metal profile	Colour	Availability
191	19101C	3 m	1.9	AISI 304	white	On request

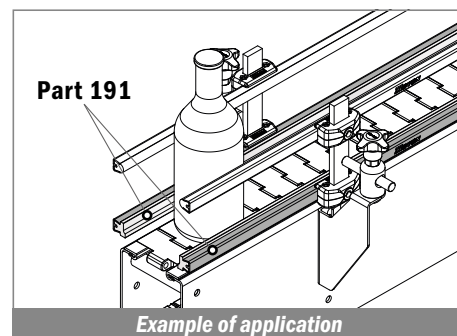
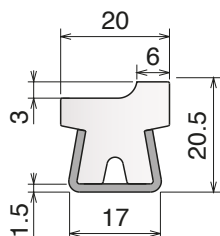
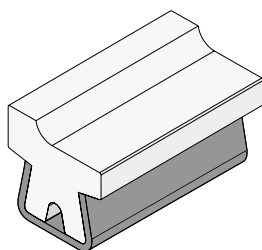

145 Guida tappeto / Belt side guide / Seitenführung für Mattenkette

Supply: 3 m bars

Part	Article-Nr.	L	T	Metal profile	Material	Availability	Type
145	14563	3 m	1.9	AISI 304	BluLub	On request	
145	14503C	3 m	1.5	AISI 304	BluLub	Stock item	

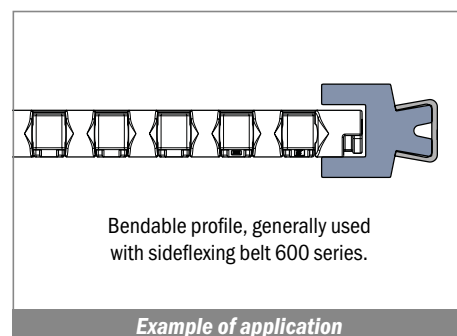
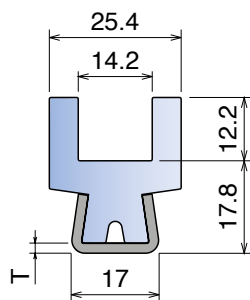
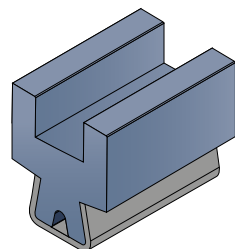

Material:

Polyethylene UHMW-PE with molecular density 5,600,000 g/mol
 Linear expansion coefficient: $1.1 \times 10^{-4} \text{ } ^\circ\text{F}^{-1}$ ($2 \times 10^{-4} \text{ } ^\circ\text{C}^{-1}$)
 Operating temperature: -40 to 176°F (-40 to +80°C)

130 Profilo in alluminio / Aluminum rail for bottle guide / Aluminium profil

Delivery: **Easy** **Standard**

Part	Article-Nr.	L	Material	Type	Availability	Supply
130	13001C	3 m	Aluminium	A	Stock item	3 m bars
130	13001	6 m	Aluminium	A	On request	6 m bars
130	13002C	3 m	Aluminium	B	On request	3 m bars

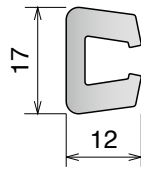
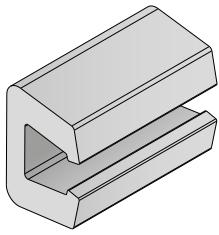

Type A

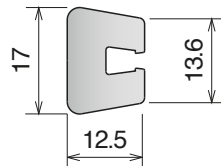

Type B

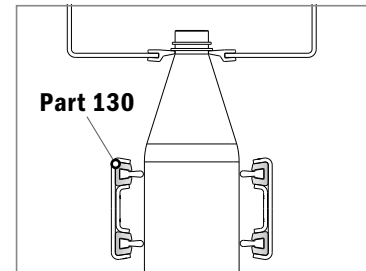

Part 130

Example of application

188 Profilo in alluminio / Aluminum rail for bottle guide / Aluminium profil

Delivery: **Easy** **Standard**

Part	Article-Nr.	L	Material	Availability	Supply
188	18801C	3 m	Aluminium	Stock item	3 m bars
188	18801	6 m	Aluminium	On request	6 m bars

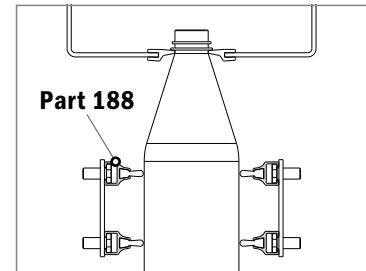
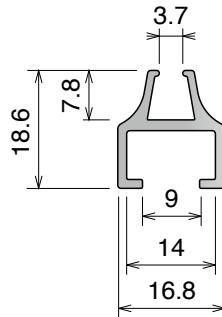
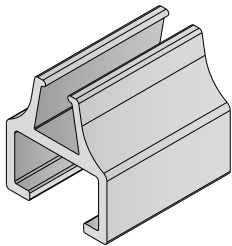

Part 188

Example of application

131 Profilo guida bottiglia / Plastic rail for bottle guide / Flaschenführungsprofil

Delivery: **Easy** **Standard**

Part	Article-Nr.	Type	Colour	Availability	Supply
131	13101B	A	BluLub	Stock item	30 m coils
131	13101	A	grey	Stock item	30 m coils
131	13102B	B	BluLub	On request	30 m coils
131	13102	B	grey	On request	30 m coils

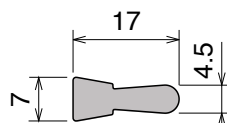
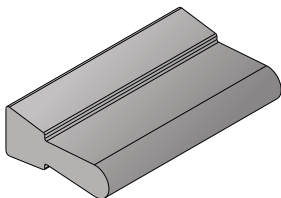

Type A

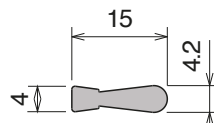

Type B

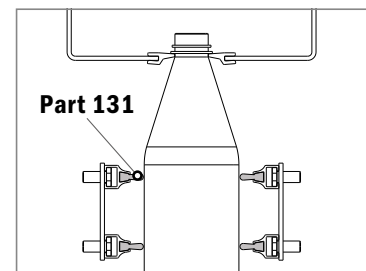

Part 131

Example of application

199 Macchina curvatrice / Bending machine / Biegemaschine

Delivery: **Easy** **Standard**

Part	Article-Nr.
199	19999



Material:

Polyethylene UHMW-PE with molecular density 5,600,000 g/mol
 Linear expansion coefficient: $1.1 \times 10^{-4} \text{ } ^\circ\text{F}^{-1}$ ($2 \times 10^{-4} \text{ } ^\circ\text{C}^{-1}$)
 Operating temperature: -40 to 176°F (-40 to +80°C)

151

Rulli per macchina curvatrice / Roller for bending machine / Rollen für Biegemaschine



Internal curve



External curve

Part	Article-Nr.	Suitable for Part.
151	15101	119 - 120 - 121 - 152

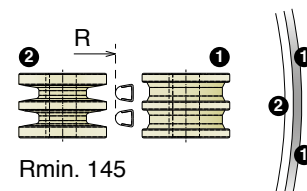
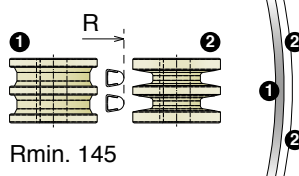

Part	Article-Nr.	Suitable for Part.
151	15102	122 - 123 - 124 - 142 - 140 - 146

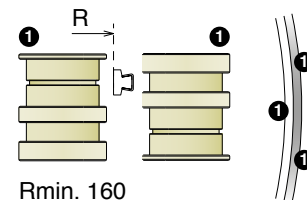
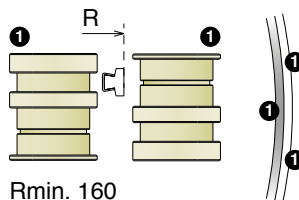
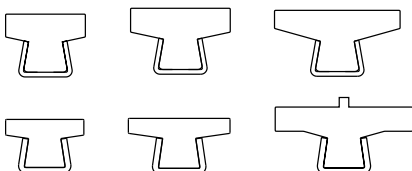

Part	Article-Nr.	Suitable for Part.
151	15103	141

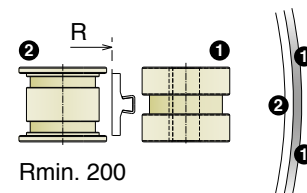
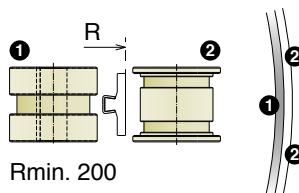

Part	Article-Nr.	Suitable for Part.
151	15104	144

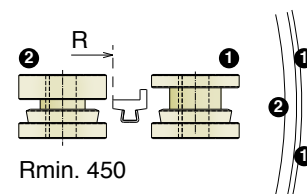
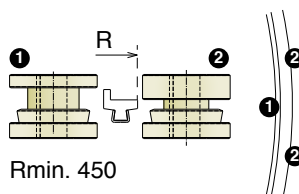
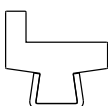

Part	Article-Nr.	Suitable for Part.
151	15105	for Ø8-Ø10-Ø12 - Ø1/2"-Ø5/8"

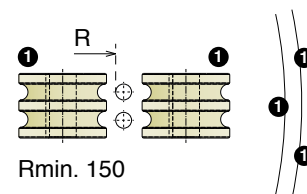
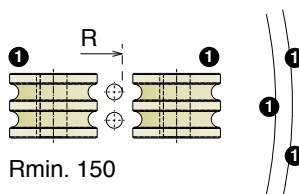
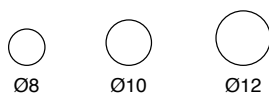

Material:

Polyethylene UHMW-PE with molecular density 5,600,000 g/mol
 Linear expansion coefficient: $1.1 \times 10^{-4} \text{ } ^\circ\text{F}^{-1}$ ($2 \times 10^{-4} \text{ } ^\circ\text{C}^{-1}$)
 Operating temperature: -40 to 176°F (-40 to +80°C)

151

Rulli per macchina curvatrice / Roller for bending machine / Rollen für Biegemaschine



Internal curve



External curve

Part	Article-Nr.	Suitable for Part.
151	15109	358

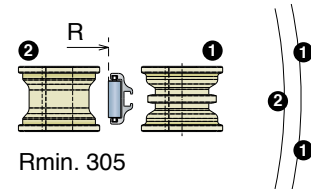
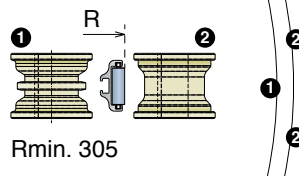

Part	Article-Nr.	Suitable for Part.
151	15110	360

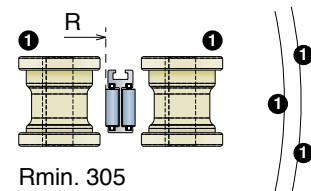
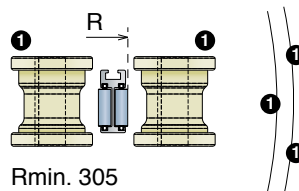
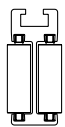

Part	Article-Nr.	Suitable for Part.
151	15106	359

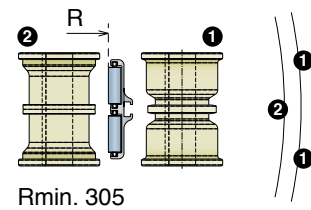
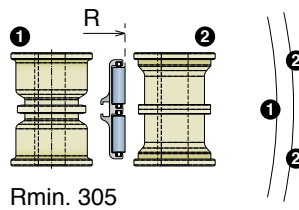
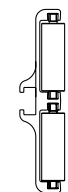

Part	Article-Nr.	Suitable for Part.
151	15107	361

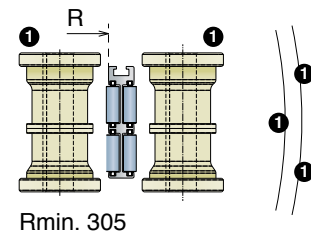
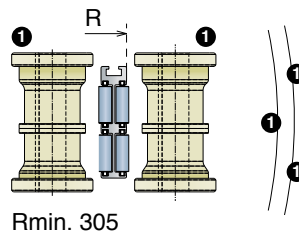
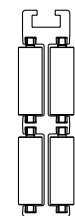

Part	Article-Nr.	Suitable for Part.
151	15108	117

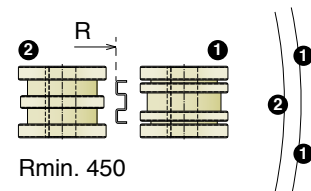
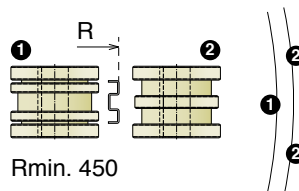

170-168-169-1036

Guide estruse / Extruded profiles / Extrudiertes profil

Material: Polyethylene UHMW-PE with molecular density 9,200,000 g/mo. **BluLub**, new material with reduced coefficient of friction and higher wear resistance. BluLub complies with the code of Federal Regulations of FDA. Linear expansion coefficient: $1.1 \times 10^{-4} \text{ } ^\circ\text{F}^{-1}$ ($2 \times 10^{-4} \text{ } ^\circ\text{C}^{-1}$) Operating temperature: -40 to 176 °F (-40 to +80 °C)

170 Guida collo / Neck guide / Nackenführung

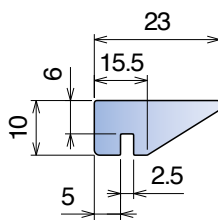
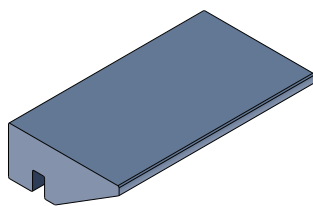

Part	Article-Nr.	L	Material	Availability	Supply
170	17001B	3 m	BluLub	Stock item	3 m bars
170	17002B	6 m	BluLub	On request	6 m bars
170	17000B	30 m	BluLub	On request	30 m coils

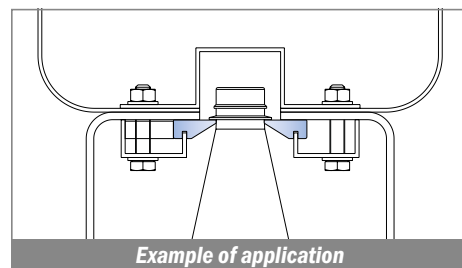

168 Guida collo / Neck guide / Nackenführung

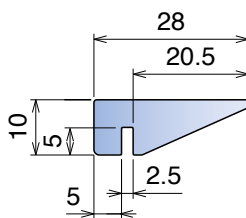
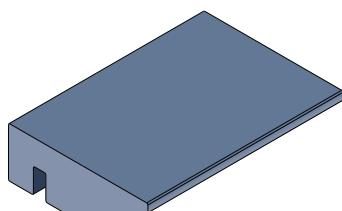

Part	Article-Nr.	L	Material	Availability	Supply
168	16801B	3 m	BluLub	Stock item	3 m bars
168	16802B	6 m	BluLub	On request	6 m bars
168	16800B	30 m	BluLub	On request	30 m coils

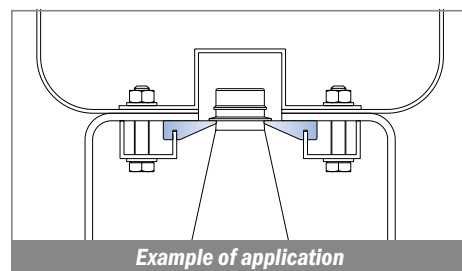

169 Guida collo / Neck guide / Nackenführung

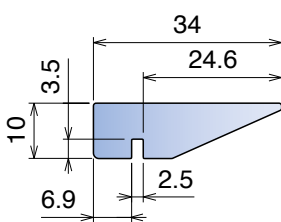
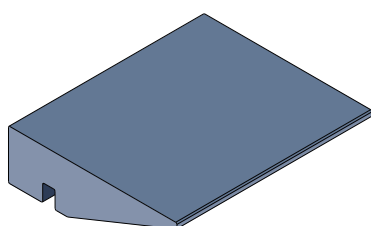

Part	Article-Nr.	L	Material	Availability	Supply
169	16901B	3 m	BluLub	Stock item	3 m bars
169	16902B	6 m	BluLub	On request	6 m bars
169	16900B	30 m	BluLub	On request	30 m coils

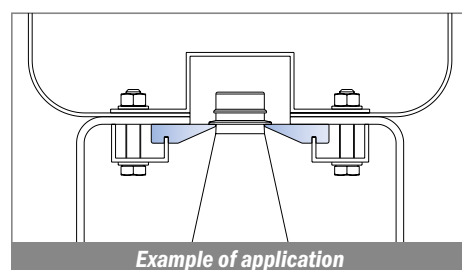

1036 Guida collo / Neck guide / Nackenführung

Fit on 1.8 - 2 mm

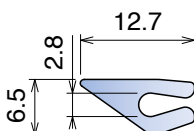
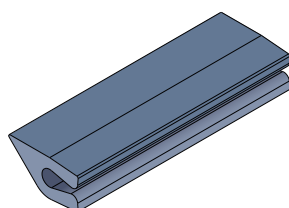

Part	Article-Nr.	L	Material	Availability	Supply
1036	103600B	30 m	BluLub	Stock item	30 m coils

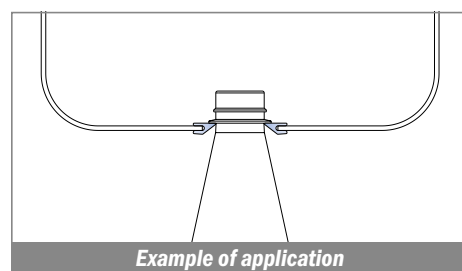

Material: Polyethylene UHMW-PE with molecular density 9,200,000 g/mo.
BluLub, new material with reduced coefficient of friction and higher wear resistance.
 BluLub complies with the code of Federal Regulations of FDA. Linear expansion coefficient:
 $1.1 \times 10^{-4} \text{ } ^\circ\text{F}^{-1}$ ($2 \times 10^{-4} \text{ } ^\circ\text{C}^{-1}$) Operating temperature: -40 to 176 °F (-40 to +80 °C)

1037-167-171-172

Guide estruse / Extruded profiles / Extrudiertes profil

1037 Guida collo / Neck guide / Nackenführung

Delivery: **Easy** **Standard** Fit on 3 mm

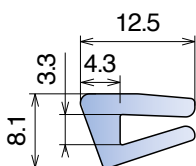
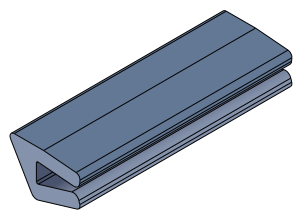

Part	Article-Nr.	L	Material	Availability	Supply
1037	103700B	30 m	BluLub	Stock item	30 m coils

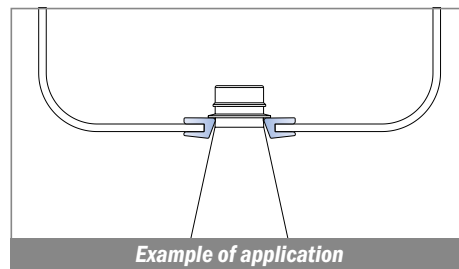

167 Guida collo / Neck guide / Nackenführung

Delivery: **Easy** **Standard** Fit on 1.8 - 2 mm

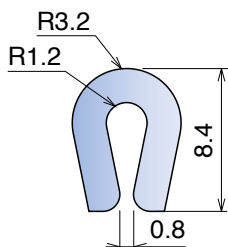
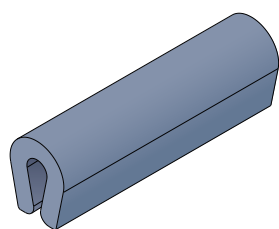

Part	Article-Nr.	L	Material	Availability	Supply
167	16700BC	3 m	BluLub	Stock item	3 m bars
167	16700B	6 m	BluLub	Stock item	6 m bars
167	16700B-30	30 m	BluLub	Stock item	30 m coils
167	16700B-75	75 m	BluLub	Stock item	75 m coils

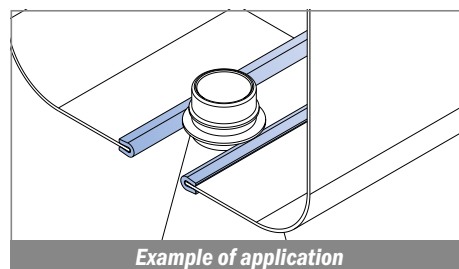

171 Guida collo / Neck guide / Nackenführung

Delivery: **Easy** **Standard** Fit on 3 mm

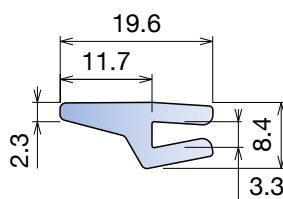
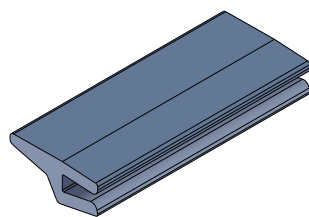

Part	Article-Nr.	L	Material	Availability	Supply
171	17100B	30 m	BluLub	Stock item	30 m coils

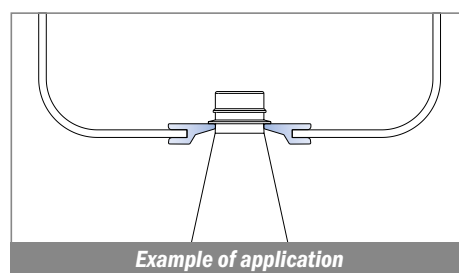

172 Guida collo / Neck guide / Nackenführung

Delivery: **Easy** **Standard** Fit on 3 mm

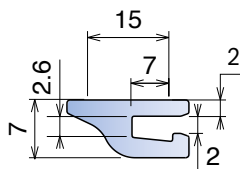
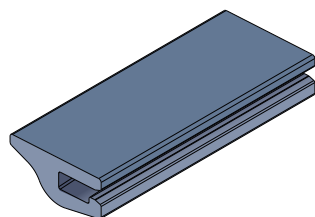

Part	Article-Nr.	L	Material	Availability	Supply
172	17200B	30 m	BluLub	Stock item	30 m coils

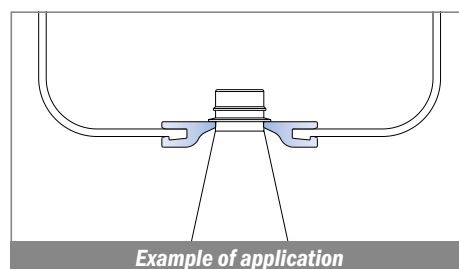

Material: Polyethylene UHMW-PE with molecular density 9,200,000 g/mo. **BluLub**, new material with reduced coefficient of friction and higher wear resistance. BluLub complies with the code of Federal Regulations of FDA. Linear expansion coefficient: $1.1 \times 10^{-4} \text{ } ^\circ\text{F}^{-1}$ ($2 \times 10^{-4} \text{ } ^\circ\text{C}^{-1}$) Operating temperature: -40 to 176 °F (-40 to +80 °C)

173 Guida collo / Neck guide / Nackenführung

Delivery: **Easy** **Standard** Fit on 1.8 - 2 mm

Part	Article-Nr.	L	Material	Availability	Supply
173	17300B	30 m	BluLub	Stock item	30 m coils

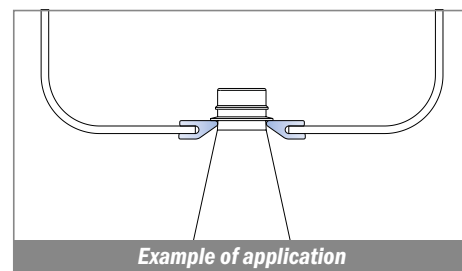
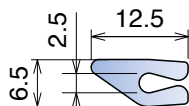
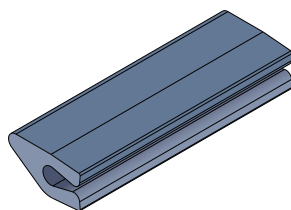

192 Guida collo / Neck guide / Nackenführung

Fit on 1.8 - 2 mm

Part	Article-Nr.	L	Material	Availability	Supply
192	19200B	30 m	BluLub	Stock item	30 m coils

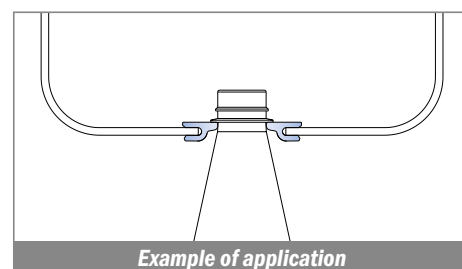
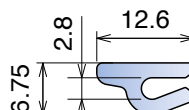
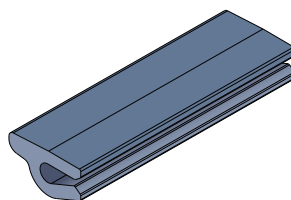

1062 Guida collo / Neck guide / Nackenführung

Delivery: **Easy** **Standard** Fit on 1.8 - 2 mm

Part	Article-Nr.	L	Material	Availability	Supply
1062	106200B	30 m	BluLub	Stock item	30 m coils

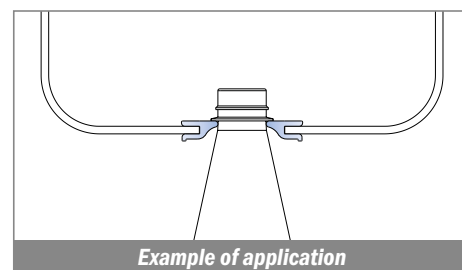
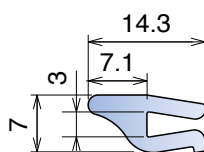
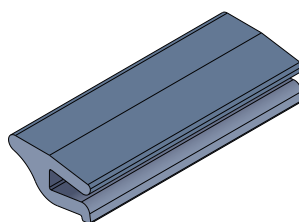

1072 Guida collo / Neck guide / Nackenführung

Delivery: **Easy** **Standard** Fit on 1.8 - 2 mm

Part	Article-Nr.	L	Material	Availability	Supply
1072	107200B	30 m	BluLub	Stock item	30 m coils

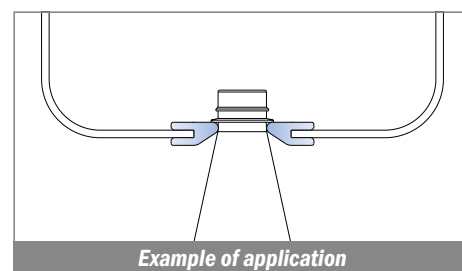
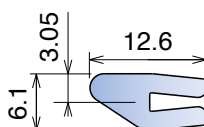
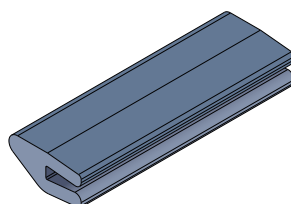

Material: Polyethylene UHMW-PE with molecular density 9,200,000 g/mo.
BluLub, new material with reduced coefficient of friction and higher wear resistance.
 BluLub complies with the code of Federal Regulations of FDA. Linear expansion coefficient:
 $1.1 \times 10^{-4} \text{ } ^\circ\text{F}^{-1}$ ($2 \times 10^{-4} \text{ } ^\circ\text{C}^{-1}$) Operating temperature: -40 to 176 °F (-40 to +80 °C)

1073

Guide estruse / Extruded profiles / Extrudiertes profil

1073

Guida collo / Neck guide / Nackenführung

Delivery: **Easy** **Standard** Fit on 1.8 - 2 mm

Part	Article-Nr.	L	Material	Availability	Supply
1073	107300B	30 m	BluLub	Stock item	30 m coils

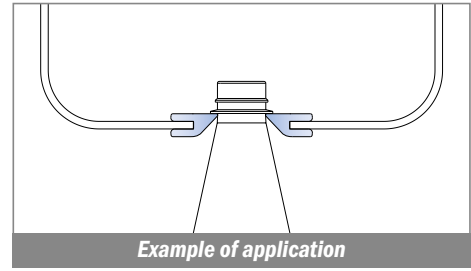
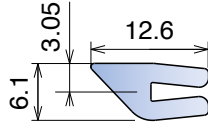
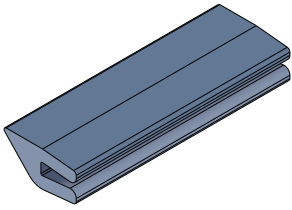

163-160-161

Guide estruse / Extruded profiles / Extrudiertes profil

Material:

Polyethylene UHMW-PE with molecular density 5,600,000 g/mol
 Linear expansion coefficient: $1.1 \times 10^{-4} \text{ } ^\circ\text{F}^{-1}$ ($2 \times 10^{-4} \text{ } ^\circ\text{C}^{-1}$)
 Operating temperature: -40 to 176°F (-40 to +80°C)

163 Profilo 25 mm per guida in alluminio / Profile 25 mm for aluminum guide / C-Profil f. Aluminiumprofil

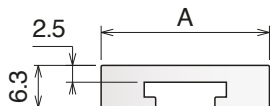
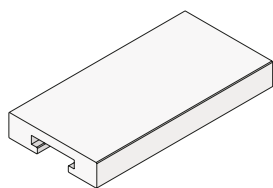

Coils available

Part	Article-Nr.	A	L	Colour	Availability	Supply
163	16303C	25,4	3 m	white	Stock item	3 m bars
163	16303	25,4	6 m	white	On request	6 m bars
163	16313C	31,75	3 m	white	Stock item	3 m bars
163	16313	31,75	6 m	white	On request	6 m bars
163	16323C	35,0	3 m	white	Stock item	3 m bars
163	16323	35,0	6 m	white	On request	6 m bars
163	16324C	38,1	3 m	white	Stock item	3 m bars
163	16324	38,1	6 m	white	On request	6 m bars

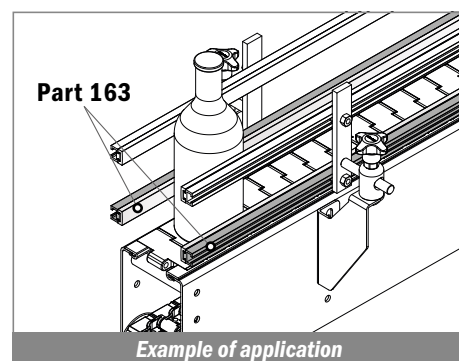

160 Profilo 20 mm per guida in alluminio / Profile 20 mm for aluminum guide / C-Profil f. Aluminiumprofil

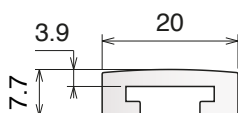
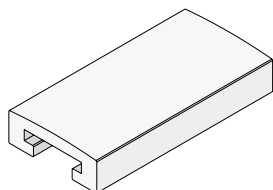

Coils available

Part	Article-Nr.	L	Colour	Availability	Supply
160	16003C	3 m	white	Stock item	3 m bars
160	16003	6 m	white	On request	6 m bars

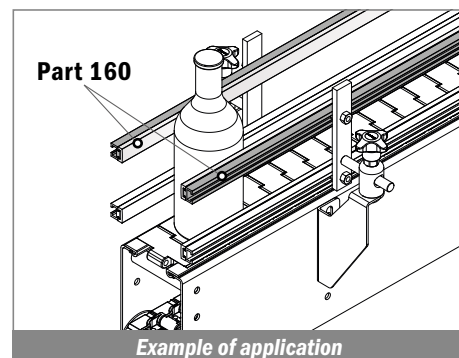

161 Profilo 20 mm per guida in alluminio / Profile 20 mm for aluminum guide / C-Profil f. Aluminiumprofil

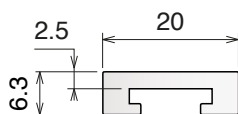
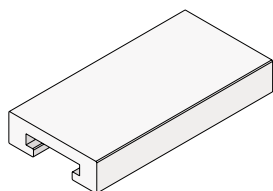

Delivery: **Easy** **Standard** Coils available

Part	Article-Nr.	L	Colour	Availability	Supply
161	16103C	3 m	white	Stock item	3 m bars
161	16103	6 m	white	On request	6 m bars

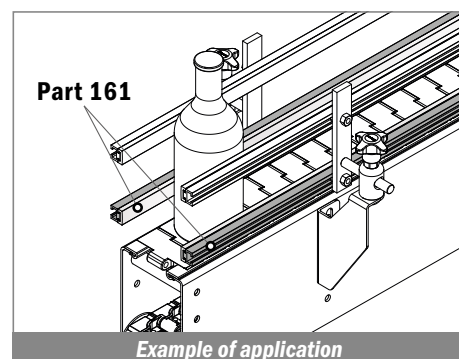

Material:

Polyethylene UHMW-PE with molecular density 5,600,000 g/mol
 Linear expansion coefficient: $1.1 \times 10^{-4} \text{ } ^\circ\text{F}^{-1}$ ($2 \times 10^{-4} \text{ } ^\circ\text{C}^{-1}$)
 Operating temperature: -40 to 176°F (-40 to +80°C)

162 Profilo tondo per guida in alluminio / Round profile for aluminum guide / Pilzprofil f. Aluminiumprofil

Coils available

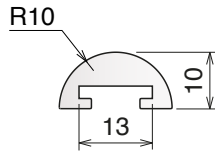
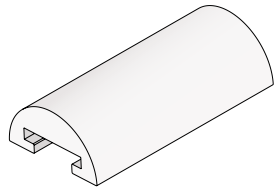

Part	Article-Nr.	L	Colour	Availability	Supply
162	16202C	3 m	green	Stock item	3 m bars
162	16202	6 m	green	On request	6 m bars
162	16203C	3 m	white	Stock item	3 m bars
162	16203	6 m	white	On request	6 m bars

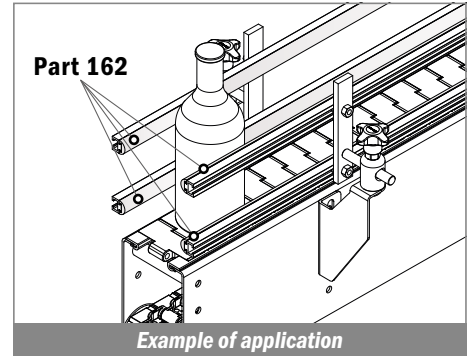

164 Guida in alluminio / Aluminum guide / Aluminiumprofil

Delivery: **Easy** Standard

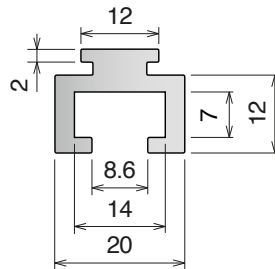
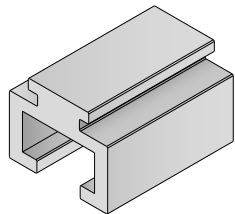

Part	Article-Nr.	L	Material	Availability	Supply
164	16401C	3 m	Aluminium	Stock item	3 m bars
164	16401	6 m	Aluminium	On request	6 m bars

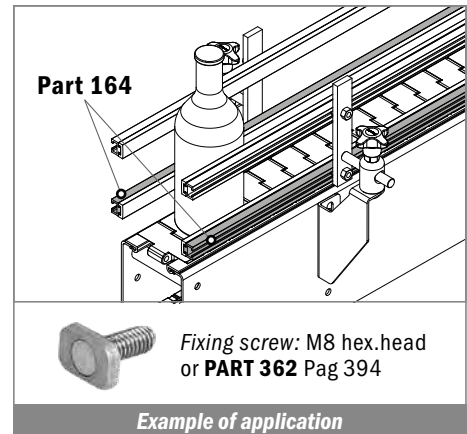

165 Guida in alluminio / Aluminum guide / Aluminiumprofil

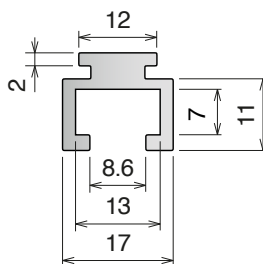
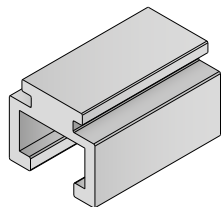

Part	Article-Nr.	L	Material	Availability	Supply
165	16501C	3 m	Aluminium	Stock item	3 m bars
165	16501	6 m	Aluminium	On request	6 m bars

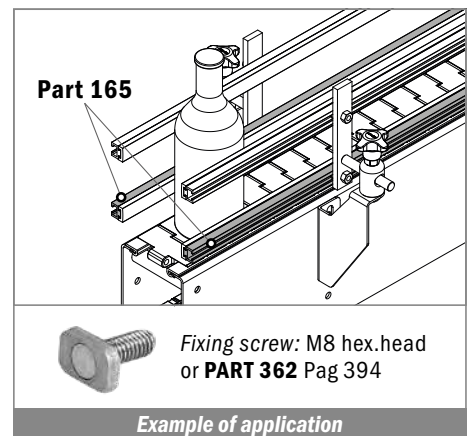

Material:

Polyethylene UHMW-PE with molecular density 5,600,000 g/mol
 Linear expansion coefficient: $1.1 \times 10^{-4} \text{ } ^\circ\text{F}^{-1}$ ($2 \times 10^{-4} \text{ } ^\circ\text{C}^{-1}$)
 Operating temperature: -40 to 176°F (-40 to +80°C)

154 Guida laterale / Side guide rail / Seitenführungen

Delivery: **Easy** Standard

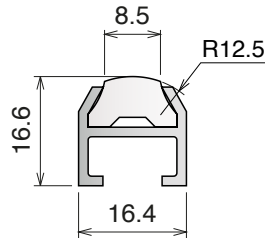
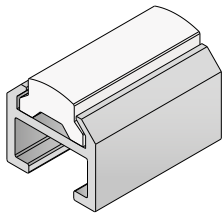

Part	Article-Nr.	L	Colour	Availability	Supply
154	15401C	3 m	white	Stock item	3 m bars
154	15401	6 m	white	On request	6 m bars
154	15401BC	3 m	BluLub	Stock item	3 m bars
154	15401B	6 m	BluLub	On request	6 m bars

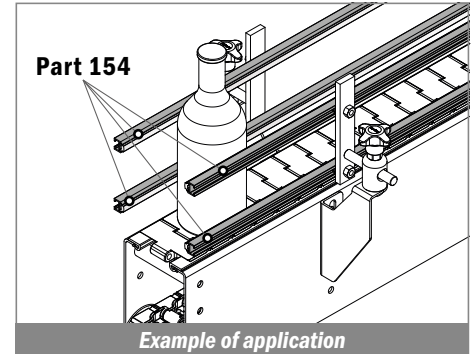

155 Guida laterale / Side guide rail / Seitenführungen

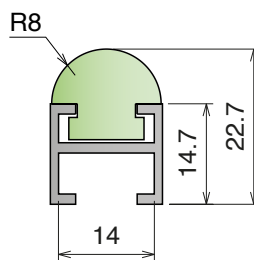
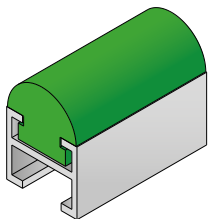

Part	Article-Nr.	L	Colour	Availability	Supply
155	15501C	3 m	green	Stock item	3 m bars
155	15501	6 m	green	On request	6 m bars

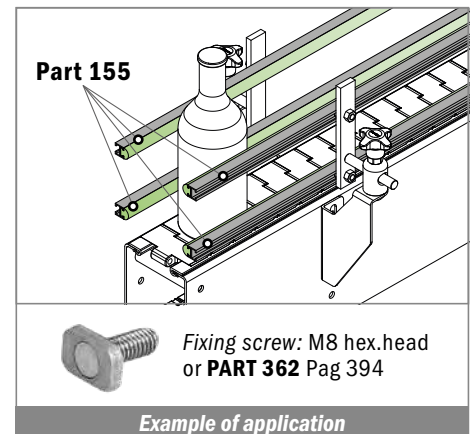

134 Guida standard / Standard guide rail / Seitenführung

Delivery: **Easy** Standard

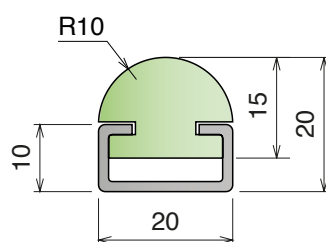
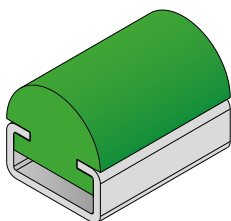

Part	Article-Nr.	L	Colour	Availability	Supply
134	13401C	3 m	green	Stock item	3 m bars
134	13401	6 m	green	On request	6 m bars

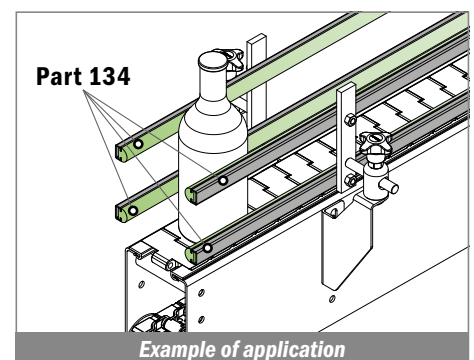

Material:

Polyethylene UHMW-PE with molecular density 5,600,000 g/mol
 Linear expansion coefficient: $1.1 \times 10^{-4} \text{ } ^\circ\text{F}^{-1}$ ($2 \times 10^{-4} \text{ } ^\circ\text{C}^{-1}$)
 Operating temperature: -40 to 176°F (-40 to +80°C)

1041-1042-1043

Guide estruse / Extruded profiles / Extrudiertes profil

1041

Profilo "C" / C-Profile / C-Profil

Fit on 5 x 25 mm

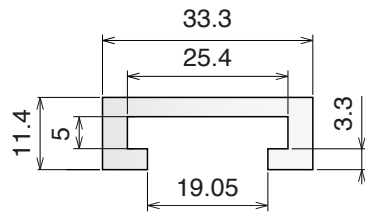
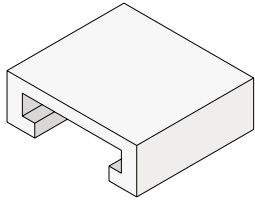
**North America STANDARD**

Part	Article-Nr.	L	Colour	Availability	Supply
1041	104103C	3 m	white	On request	3 m bars
1041	104103	6 m	white	On request	6 m bars

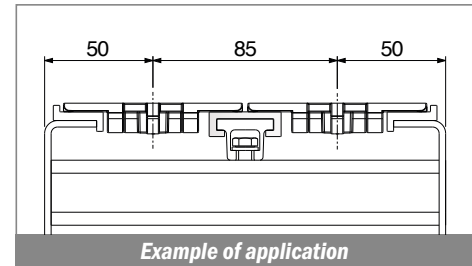

1042

Profilo "C" / C-Profile / C-Profil

Fit on 6 x 50 mm

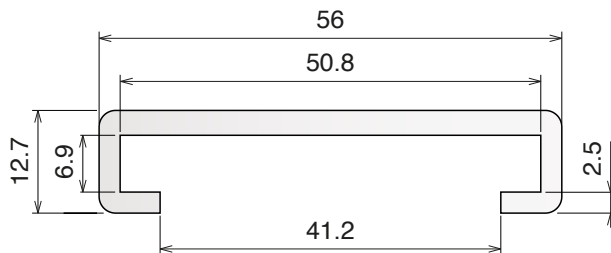
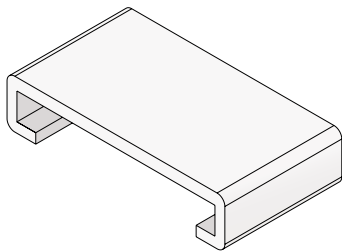
**North America STANDARD**

Part	Article-Nr.	L	Colour	Availability	Supply
1042	104203C	3 m	white	On request	3 m bars
1042	104203	6 m	white	On request	6 m bars

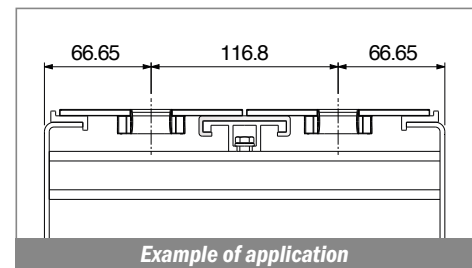

1043

Profilo "C" / C-Profile / C-Profil

Fit on 6 x 50 mm

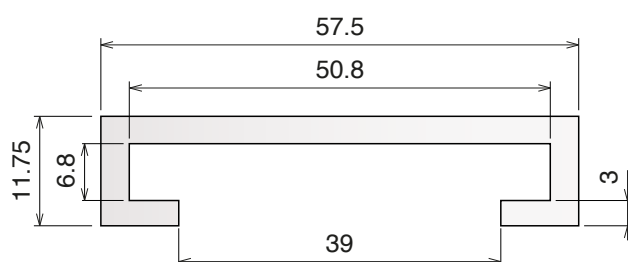
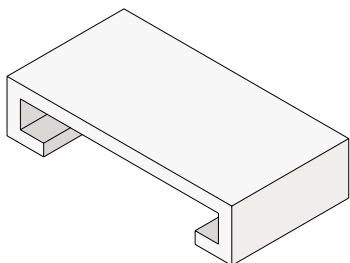
**North America STANDARD**

Part	Article-Nr.	L	Colour	Availability	Supply
1043	104303C	3 m	white	On request	3 m bars
1043	104303	6 m	white	On request	6 m bars

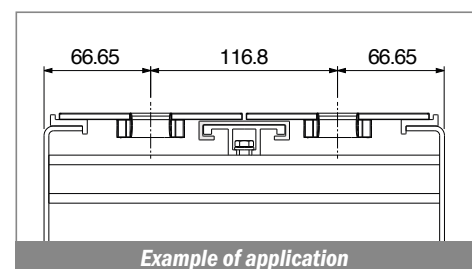

1044-1045-1053

Guide estruse / Extruded profiles / Extrudiertes Profil

Material:

Polyethylene UHMW-PE with molecular density 5,600,000 g/mol
 Linear expansion coefficient: $1.1 \times 10^{-4} \text{ } ^\circ\text{F}^{-1}$ ($2 \times 10^{-4} \text{ } ^\circ\text{C}^{-1}$)
 Operating temperature: -40 to 176°F (-40 to +80°C)

1044

Profilo "C" / C-Profile / C-Profil

Fit on 12.7 x 38.1 mm

North America STANDARD

Part	Article-Nr.	L	Colour	Availability	Supply
1044	104403C	3 m	white	On request	3 m bars
1044	104403	6 m	white	On request	6 m bars

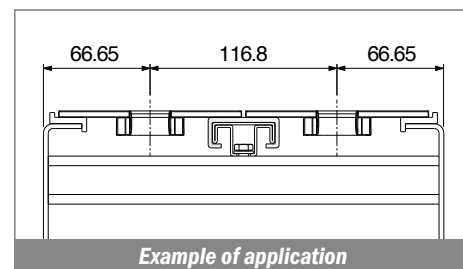
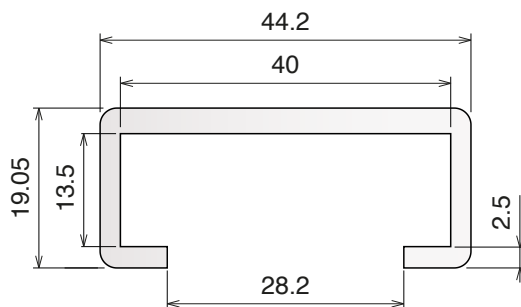
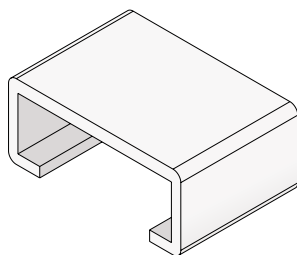

1045

Profilo "C" / C-Profile / C-Profil

Fit on 12.7 x 50.8 mm

North America STANDARD

Part	Article-Nr.	L	Colour	Availability	Supply
1045	104503C	3 m	white	On request	3 m bars
1045	104503	6 m	white	On request	6 m bars

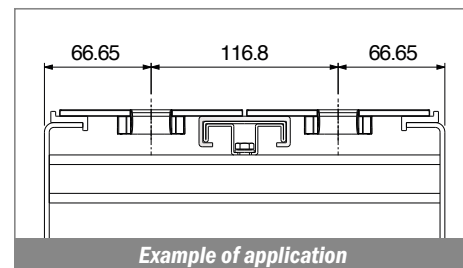
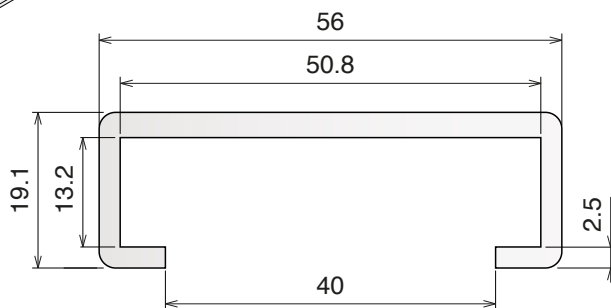
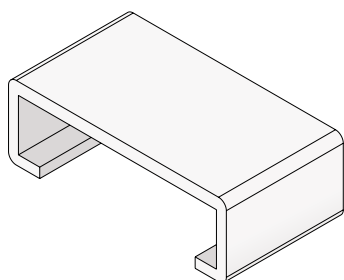

1053

Copri profilo / Bar cover / Abdeckprofil

Fit on 6.35 x 38.1 mm

North America STANDARD

Part	Article-Nr.	L	Colour	Availability	Supply
1053	105303C	3 m	white	On request	3 m bars
1053	105303	6 m	white	On request	6 m bars

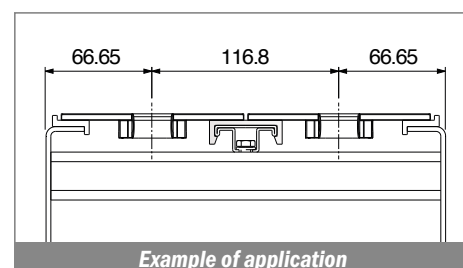
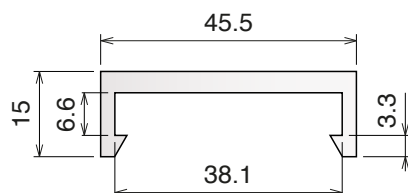
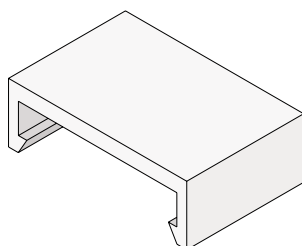

Material:

Polyethylene UHMW-PE with molecular density 5,600,000 g/mol
 Linear expansion coefficient: $1.1 \times 10^{-4} \text{ } ^\circ\text{F}^{-1}$ ($2 \times 10^{-4} \text{ } ^\circ\text{C}^{-1}$)
 Operating temperature: -40 to 176°F (-40 to +80°C)

1054 Copri profilo / Bar cover / Abdeckprofil

Fit on 6.35 x 38.1 mm

North America STANDARD

Part	Article-Nr.	L	Colour	Availability	Supply
1054	105403C	3 m	white	On request	3 m bars
1054	105403	6 m	white	On request	6 m bars

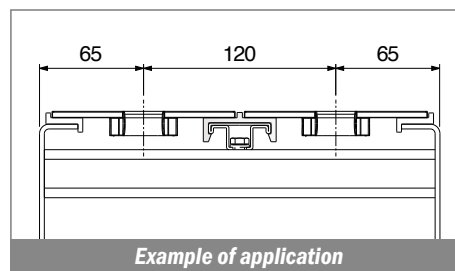
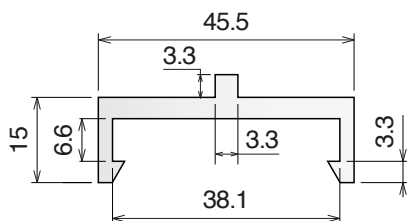
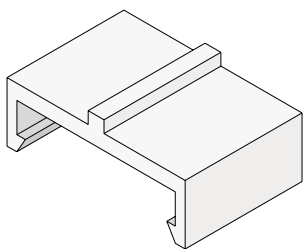

137 Profilo "C" / C-Profile / C-Profil

Delivery: **Easy** **Standard**



Part	Article-Nr.	L	A	B	Colour	Availability	Supply
137	13701C	3 m	8,5	14	green	Stock item	3 m bars
137	13701	6 m	8,5	14	green	On request	6 m bars
137	13701BC	3 m	8,5	14	BluLub	Stock item	3 m bars
137	13701B	6 m	8,5	14	BluLub	On request	6 m bars
137	13702C	3 m	8,5	14	black	Stock item	3 m bars
137	13702	6 m	8,5	14	black	On request	6 m bars
137	13711C	3 m	10,5	16	green	Stock item	3 m bars
137	13711	6 m	10,5	16	green	On request	6 m bars
137	13711BC	3 m	10,5	16	BluLub	Stock item	3 m bars
137	13711B	6 m	10,5	16	BluLub	On request	6 m bars

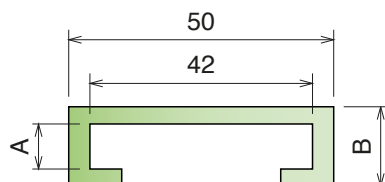
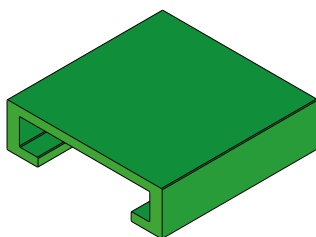

USE WITH STEEL 40 x 8 mm or 40 x 10 mm

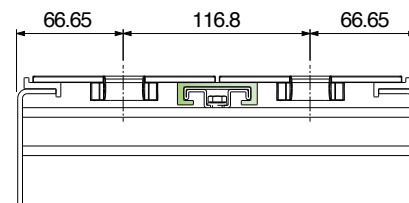

Part	Article-Nr.	L	Colour	Availability	Supply
137	13720	6 m	white	On request	6 m bars

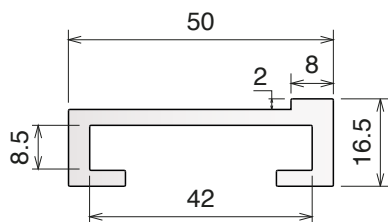
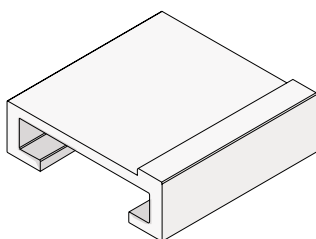

USE WITH STEEL 40 x 8 mm

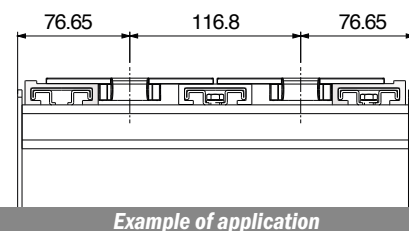

117-1055-159

Guide estruse / Extruded profiles / Extrudiertes profil

Material:

Polyethylene UHMW-PE with molecular density 5,600,000 g/mol
 Linear expansion coefficient: $1.1 \times 10^{-4} \text{ } ^\circ\text{F}^{-1}$ ($2 \times 10^{-4} \text{ } ^\circ\text{C}^{-1}$)
 Operating temperature: -40 to 176°F (-40 to +80°C)

117 Profilo Omega / M-Profile / M-Profil

Delivery: **Easy** Standard

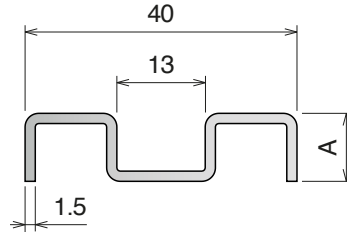
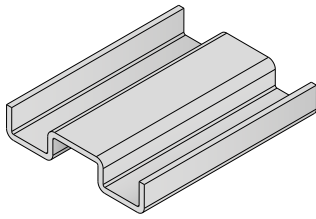

Part	Article-Nr.	L	A	Material	Availability	Supply
117	11701C	3 m	8	AISI 304	Stock item	3 m bars
117	11701	6 m	8	AISI 304	On request	6 m bars
117	11702C	3 m	10	AISI 304	Stock item	3 m bars
117	11702	6 m	10	AISI 304	On request	6 m bars
117	11703C	3 m	6	AISI 304	Stock item	3 m bars
117	11703	6 m	6	AISI 304	On request	6 m bars

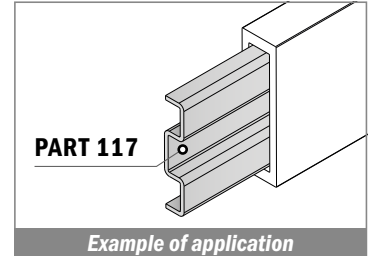

1055 Guida in acciaio inox / Stainless steel guide / Edelstahlprofil

Delivery: **Easy** Standard

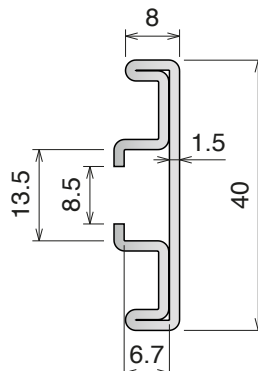
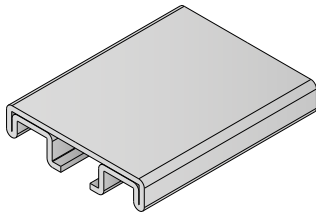

Part	Article-Nr.	L	Material	Availability	Supply
1055	105501C	3 m	AISI 304	Stock item	3 m bars
1055	105501	6 m	AISI 304	On request	6 m bars

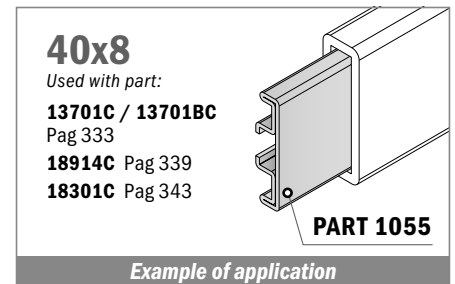

159 Guida in alluminio / Aluminum guide / Aluminiumprofil

Part	Article-Nr.	L	Material	Availability	Supply
159	15901C	3 m	Aluminium	Stock item	3 m bars
159	15901	6 m	Aluminium	On request	6 m bars

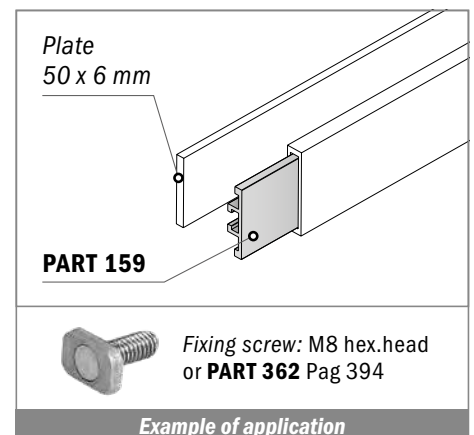
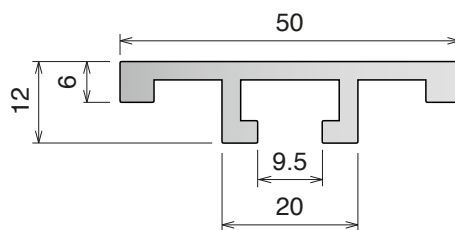
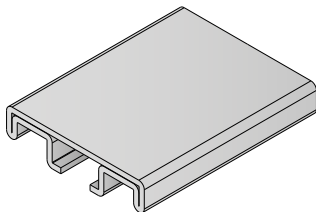

135 Guida laterale H.78 mm / Side guide H.78 mm / Seitenführung H.78 mm

Delivery: **Easy** **Standard** For plate: 60 x 6 mm

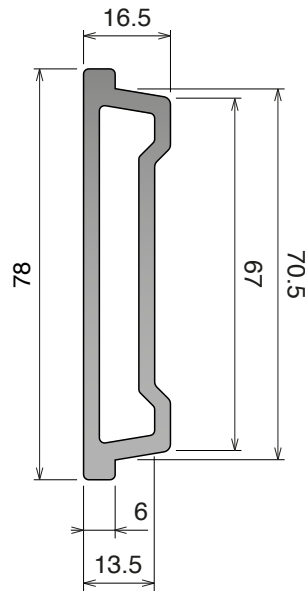
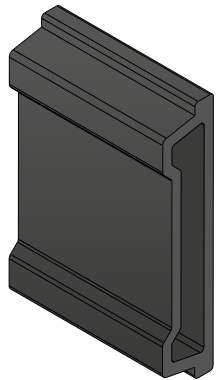

Part	Article-Nr.	L	Colour	Availability	Supply
135	13501C	3 m	black	Stock item	3 m bars
135	13501	6 m	black	On request	6 m bars
135	13502C	3 m	blu	Stock item	3 m bars
135	13502	6 m	blu	On request	6 m bars

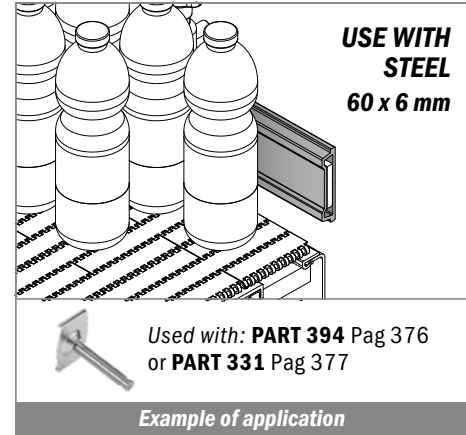

136 Guida laterale H.87 mm / Side guide H.87 mm / Seitenführung H.87 mm

Delivery: **Easy** **Standard** For plate: 60 x 6 mm

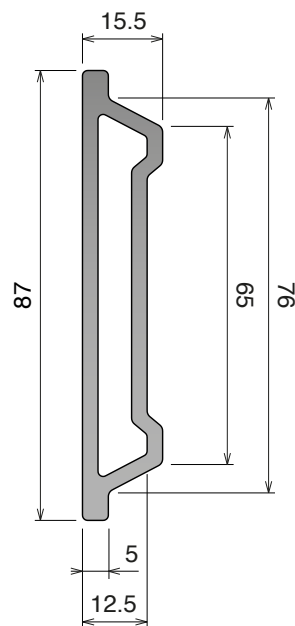
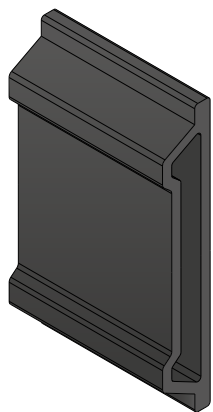

Part	Article-Nr.	L	Colour	Availability	Supply
136	13601C	3 m	black	Stock item	3 m bars
136	13601	6 m	black	On request	6 m bars
136	13602C	3 m	blu	Stock item	3 m bars
136	13602	6 m	blu	On request	6 m bars

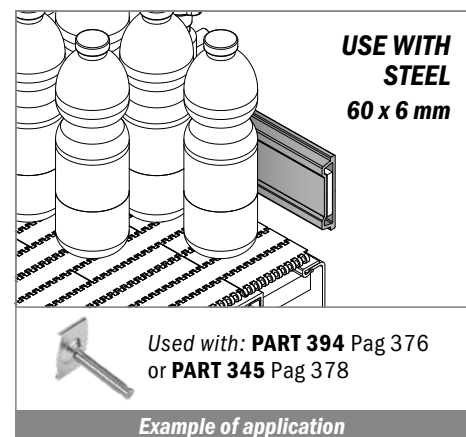

1063-1064

Guide estruse / Extruded profiles / Extrudiertes profil

Material:

Polyethylene UHMW-PE with molecular density 5,600,000 g/mol
Linear expansion coefficient: $1.1 \times 10^{-4} \text{ } ^\circ\text{F}^{-1}$ ($2 \times 10^{-4} \text{ } ^\circ\text{C}^{-1}$)
Operating temperature: -40 to 176°F (-40 to +80°C)

1063

Guida laterale / Side guide rail / Seitenführung

Delivery: **Easy** **Standard** For plate: 30 x 4 mm

Part	Article-Nr.	L	Colour	Availability	Supply
1063	106301C	3 m	black	Stock item	3 m bars
1063	106302C	3 m	green	Stock item	3 m bars

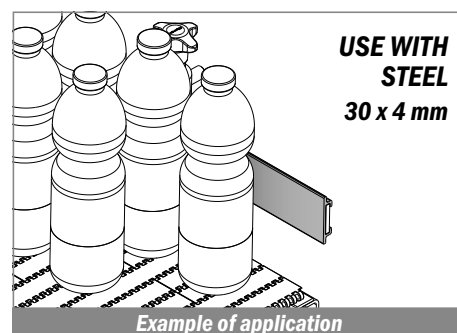
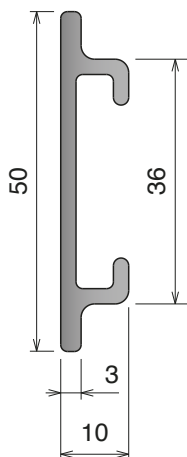
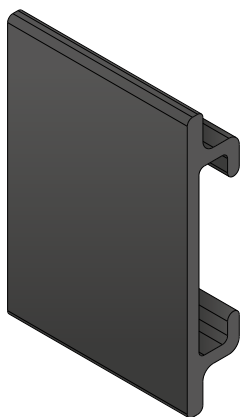

1064

Guida laterale / Side guide rail / Seitenführung

Delivery: **Easy** **Standard** For plate: 55 x 4 mm

Part	Article-Nr.	L	Colour	Availability	Supply
1064	106401C	3 m	black	Stock item	3 m bars

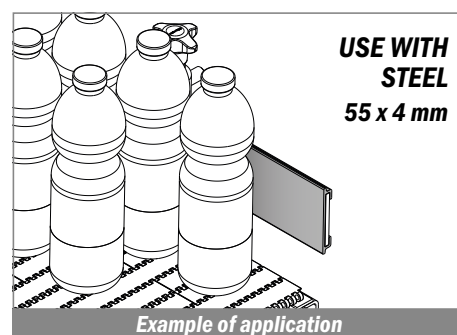
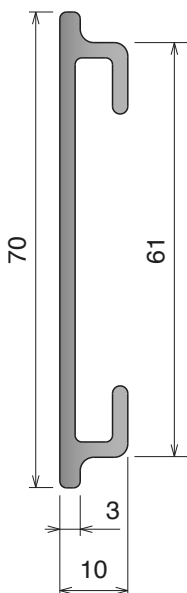
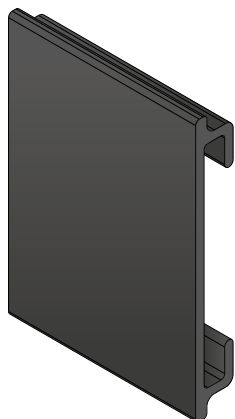

Material: Polyethylene UHMW-PE with molecular density 9,200,000 g/mo.
BluLub, new material with reduced coefficient of friction and higher wear resistance.
 BluLub complies with the code of Federal Regulations of FDA. Linear expansion coefficient:
 $1.1 \times 10^{-4} \text{ } ^\circ\text{F}^{-1}$ ($2 \times 10^{-4} \text{ } ^\circ\text{C}^{-1}$) Operating temperature: -40 to 176 °F (-40 to +80 °C)

158 Guida laterale / Side guide rail / Seitenführung

Delivery: **Easy** **Standard**

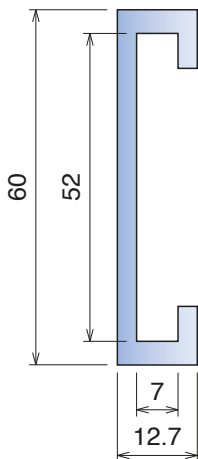
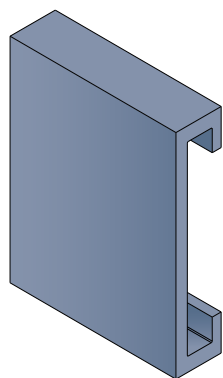

Part	Article-Nr.	L	Material	Availability	Supply
158	15800C	3 m	grey	Stock item	3 m bars
158	15800BC	3 m	BluLub	Stock item	3 m bars

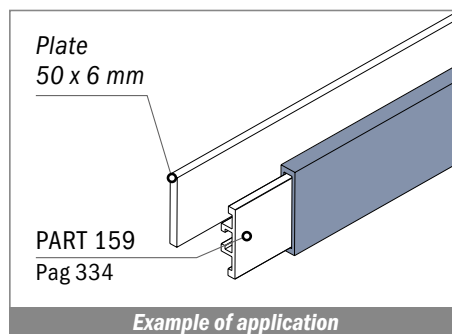

Guida laterale / Side guide rail / Seitenführung

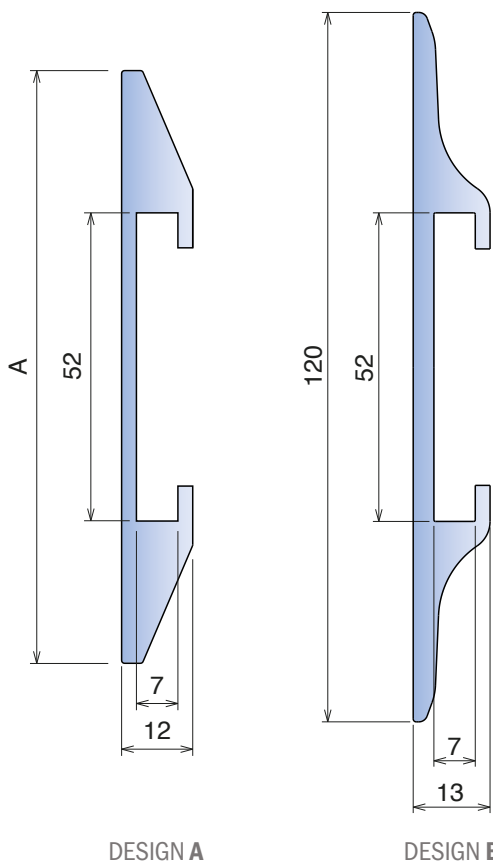
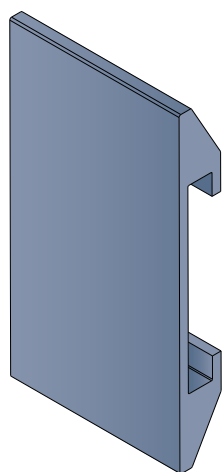

DESIGN A

DESIGN B



Part	Article-Nr.	L	A	Material	Availability	Supply	Design
158	15801C	3 m	90	grey	On request	3 m bars	A
158	15801BC	3 m	90	BluLub	Stock item	3 m bars	A
158	15802C	3 m	100	grey	On request	3 m bars	A
158	15802BC	3 m	100	BluLub	Stock item	3 m bars	A
158	15803C	3 m	120	grey	On request	3 m bars	B
158	15803BC	3 m	120	BluLub	Stock item	3 m bars	B

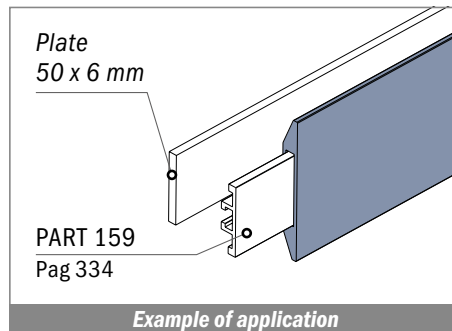

182-1065

Guide estruse / Extruded profiles / Extrudiertes profil

Material: Polyethylene UHMW-PE with molecular density 9,200,000 g/mo.
BluLub, new material with reduced coefficient of friction and higher wear resistance.
 BluLub complies with the code of Federal Regulations of FDA. Linear expansion coefficient:
 $1.1 \times 10^{-4} \text{ } ^\circ\text{F}^{-1}$ ($2 \times 10^{-4} \text{ } ^\circ\text{C}^{-1}$) Operating temperature: -40 to 176 °F (-40 to +80 °C)

182 Guida laterale / Side guide rail / Seitenführung

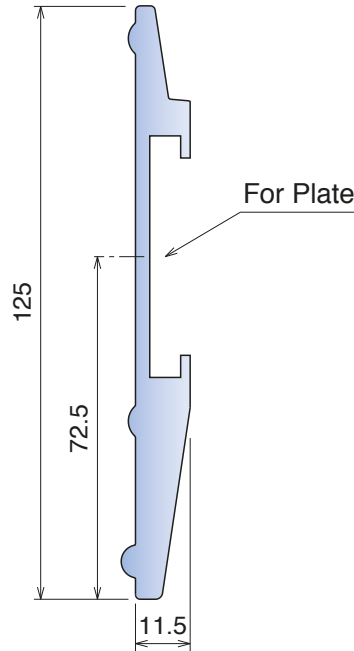
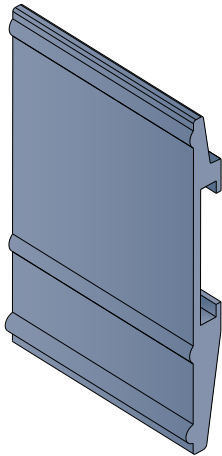

Part	Article-Nr.	L	For plate	Material	Availability	Supply
182	18214C	3 m	40 x 8 mm	grey	On request	3 m bars
182	18210BC	3 m	40 x 8 mm	BluLub	On request	3 m bars
182	18204C	3 m	50 x 6 mm	grey	Stock item	3 m bars
182	18200BC	3 m	50 x 6 mm	BluLub	Stock item	3 m bars

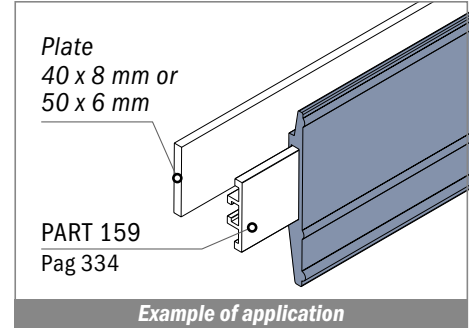

1065 Guida laterale / Side guide rail / Seitenführung

For plate: 50 x 6 mm

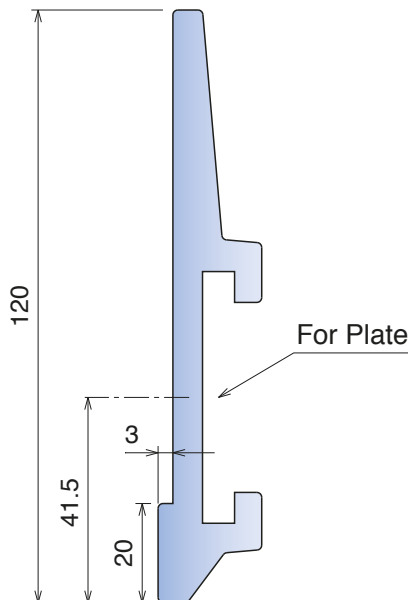
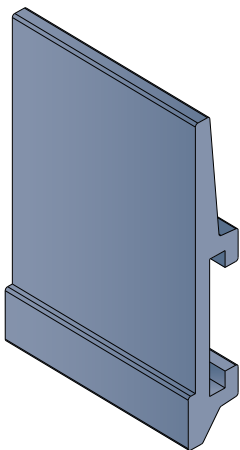

Part	Article-Nr.	L	Material	Availability	Supply
1065	106504C	3 m	grey	On request	3 m bars
1065	106500BC	3 m	BluLub	On request	3 m bars

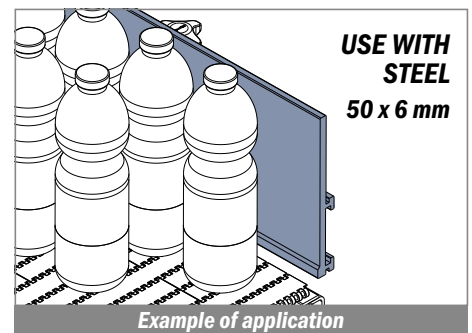

Material: Polyethylene UHMW-PE with molecular density 9,200,000 g/mo.
BluLub new material with reduced coefficient of friction and higher wear resistance.
 BluLub complies with the code of Federal Regulations of FDA. Linear expansion coefficient:
 $1.1 \times 10^{-4} \text{ } ^\circ\text{F}^{-1}$ ($2 \times 10^{-4} \text{ } ^\circ\text{C}^{-1}$) Operating temperature: -40 to 176 °F (-40 to +80 °C)

189 Guida laterale / Side guide rail / Seitenführung

Delivery: **Easy** **Standard**

Part	Article-Nr.	L	For plate	Material	Availability	Supply
189	18914C	3 m	40 x 8 mm	grey	On request	3 m bars
189	18910BC	3 m	40 x 8 mm	BluLub	Stock item	3 m bars
189	18904C	3 m	50 x 6 mm	grey	On request	3 m bars
189	18900BC	3 m	50 x 6 mm	BluLub	Stock item	3 m bars

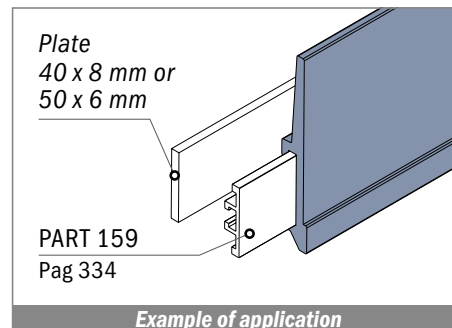
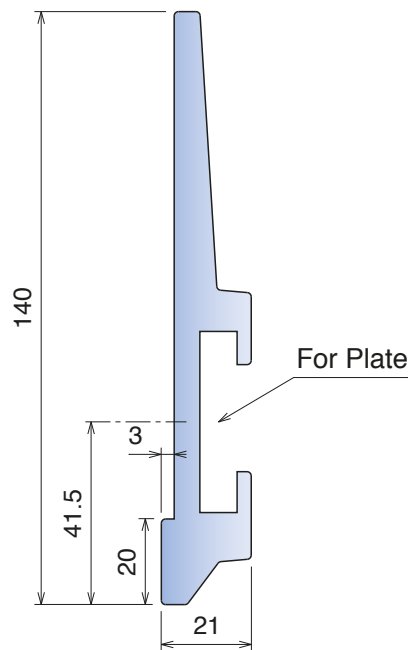
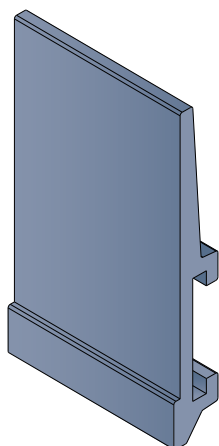

Guida laterale / Side guide rail / Seitenführung

Part	Article-Nr.	L	A	For plate	Material	Availability	Supply
189	18944C	3 m	40	60 x 5 mm	grey	Stock item	3 m bars
189	18940BC	3 m	40	60 x 5 mm	BluLub	Stock item	3 m bars
189	18924C	3 m	20	60 x 6 mm	grey	Stock item	3 m bars
189	18920BC	3 m	20	60 x 6 mm	BluLub	Stock item	3 m bars
189	18934C	3 m	40	60 x 6 mm	grey	Stock item	3 m bars
189	18930BC	3 m	40	60 x 6 mm	BluLub	Stock item	3 m bars

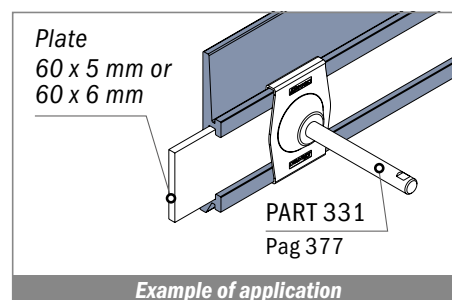
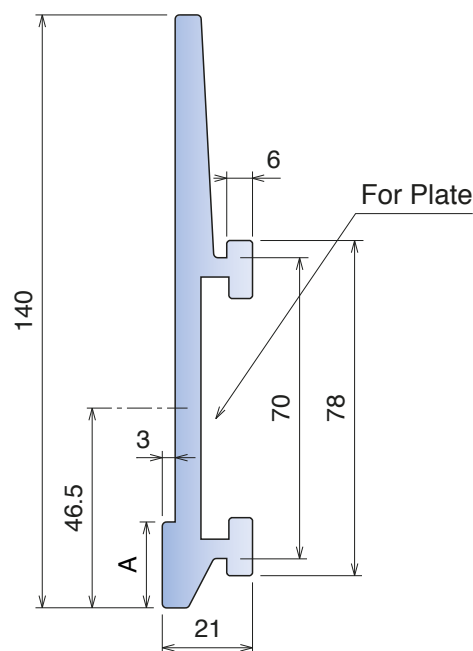
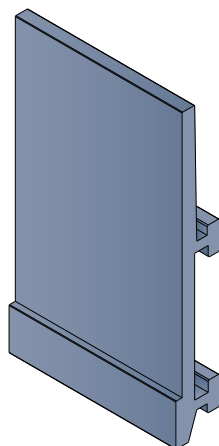

Material: Polyethylene UHMW-PE with molecular density 9,200,000 g/mo.
BluLub, new material with reduced coefficient of friction and higher wear resistance.
 BluLub complies with the code of Federal Regulations of FDA. Linear expansion coefficient:
 $1.1 \times 10^{-4} \text{ } ^\circ\text{F}^{-1}$ ($2 \times 10^{-4} \text{ } ^\circ\text{C}^{-1}$) Operating temperature: -40 to 176 °F (-40 to +80 °C)

193 Guida laterale / Side guide rail / Seitenführung

Delivery: **Easy** **Standard** For plate: 60 x 6 mm

Part	Article-Nr.	L	Material	Availability	Supply
193	19324C	3 m	grey	Stock item	3 m bars
193	19320BC	3 m	BluLub	Stock item	3 m bars

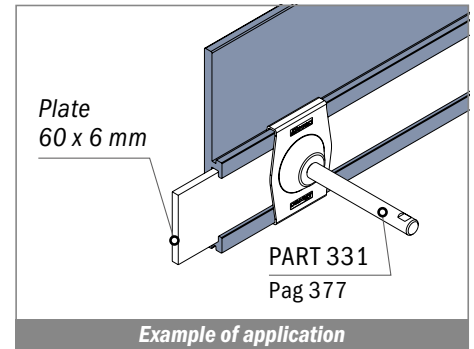
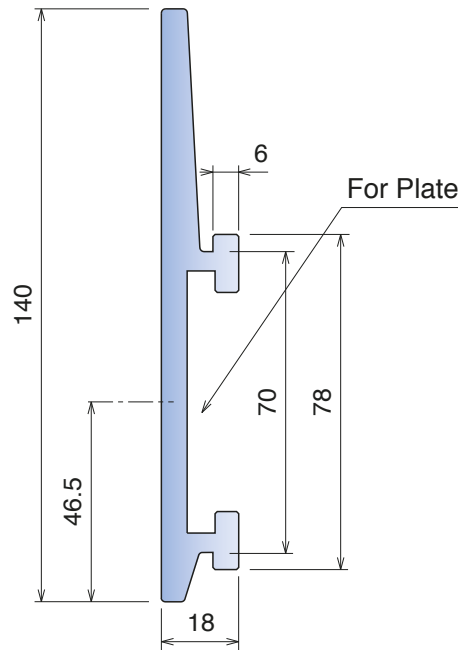
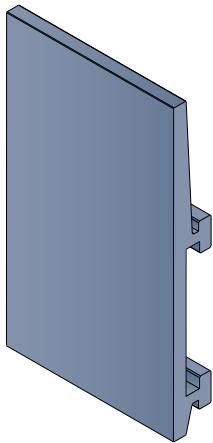

187 Guida laterale / Side guide rail / Seitenführung

For plate: 60 x 6 mm

Part	Article-Nr.	L	A	Material	Availability	Supply
187	18724C	3 m	12	grey	Stock item	3 m bars
187	18720BC	3 m	12	BluLub	Stock item	3 m bars
187	18734C	3 m	20	grey	Stock item	3 m bars
187	18730BC	3 m	20	BluLub	Stock item	3 m bars
187	18744C	3 m	40	grey	Stock item	3 m bars
187	18740BC	3 m	40	BluLub	Stock item	3 m bars

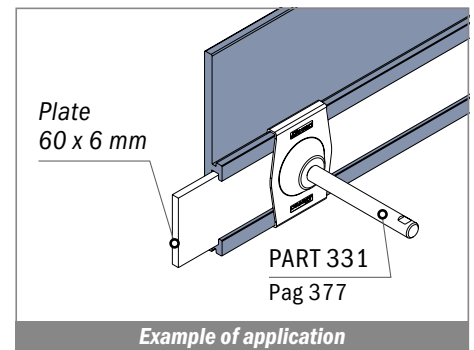
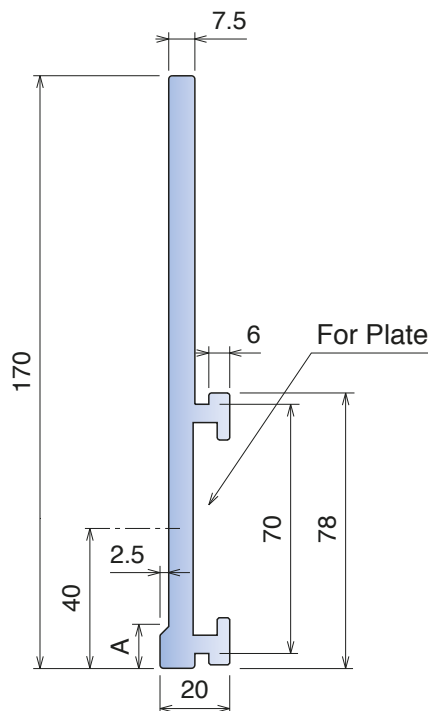
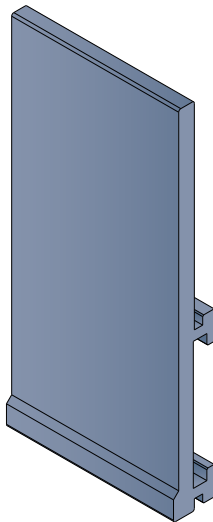

Material: Polyethylene UHMW-PE with molecular density 9,200,000 g/mo.
BluLub, new material with reduced coefficient of friction and higher wear resistance.
 BluLub complies with the code of Federal Regulations of FDA. Linear expansion coefficient:
 $1.1 \times 10^{-4} \text{ } ^\circ\text{F}^{-1}$ ($2 \times 10^{-4} \text{ } ^\circ\text{C}^{-1}$) Operating temperature: -40 to 176 °F (-40 to +80 °C)

1056 Guida laterale / Side guide rail / Seitenführung

For plate: 60 x 6 mm

Part	Article-Nr.	L	A	Material	Availability	Supply
1056	105604C	3 m	10	grey	Stock item	3 m bars
1056	105600BC	3 m	10	BluLub	Stock item	3 m bars
1056	105634C	3 m	40	grey	Stock item	3 m bars
1056	105630BC	3 m	40	BluLub	Stock item	3 m bars

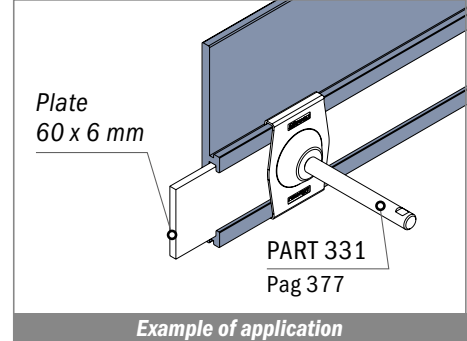
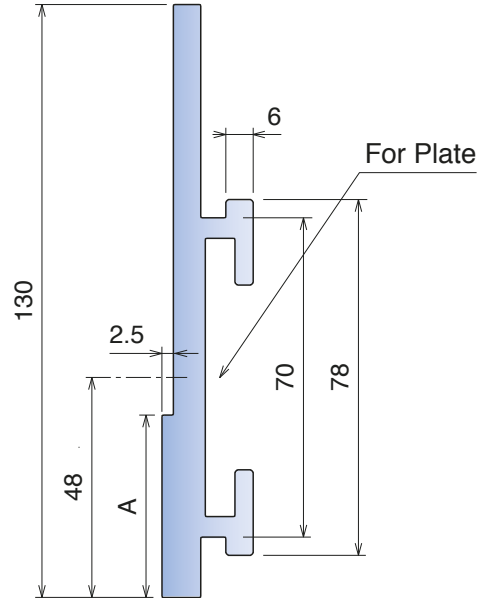
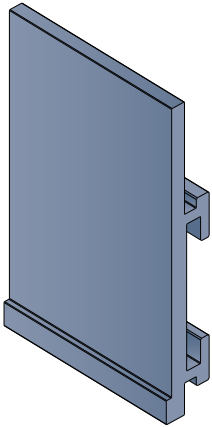

1057 Guida laterale / Side guide rail / Seitenführung

Delivery: **Easy** **Standard** For plate: 60 x 6 mm



Part	Article-Nr.	L	Material	Availability	Supply
1057	105704C	3 m	grey	Stock item	3 m bars
1057	105700BC	3 m	BluLub	Stock item	3 m bars

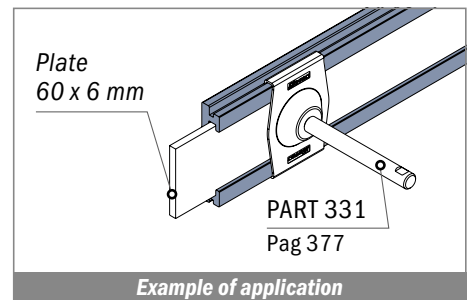
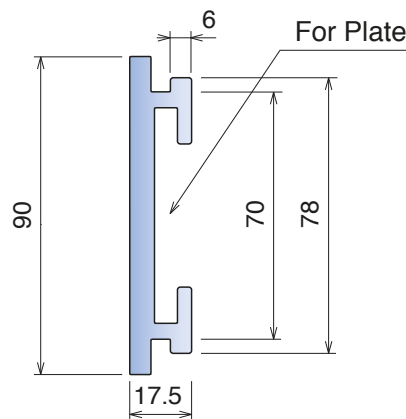
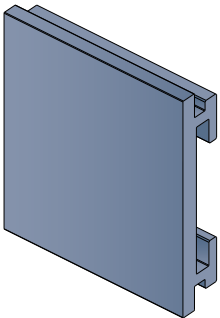

Material: Polyethylene UHMW-PE with molecular density 9,200,000 g/mo.
BluLub, new material with reduced coefficient of friction and higher wear resistance.
 BluLub complies with the code of Federal Regulations of FDA. Linear expansion coefficient:
 $1.1 \times 10^{-4} \text{ } ^\circ\text{F}^{-1}$ ($2 \times 10^{-4} \text{ } ^\circ\text{C}^{-1}$) Operating temperature: -40 to 176 °F (-40 to +80 °C)

186 Guida laterale / Side guide rail / Seitenführung

For plate: 50 x 6 mm

Part	Article-Nr.	L	Material	Availability	Supply
186	18604C	3 m	grey	On request	3 m bars
186	18600BC	3 m	BluLub	On request	3 m bars

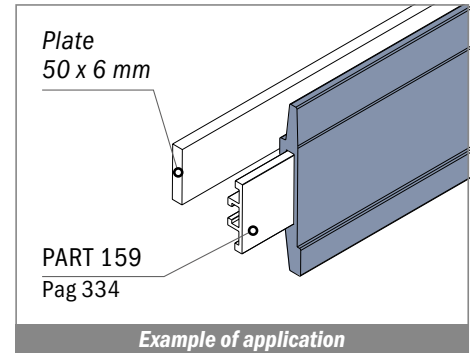
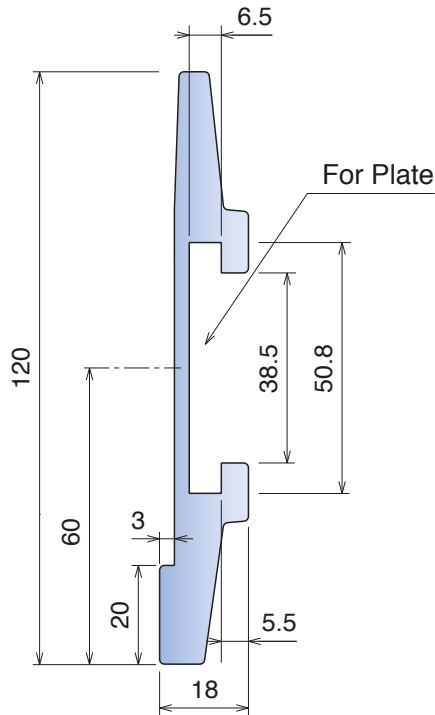
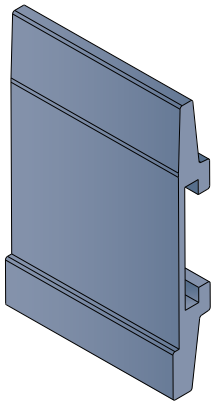

1061 Guida laterale / Side guide rail / Seitenführung

For plate: 60 x 6 mm

Part	Article-Nr.	L	Material	Availability	Supply
1061	106104C	3 m	grey	On request	3 m bars
1061	106104BC	3 m	BluLub	On request	3 m bars

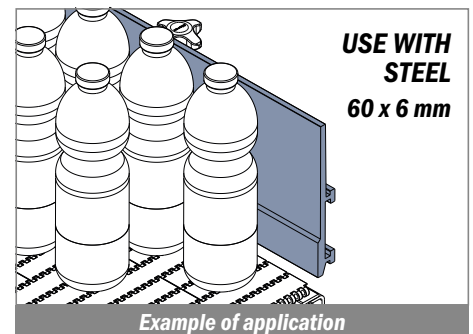
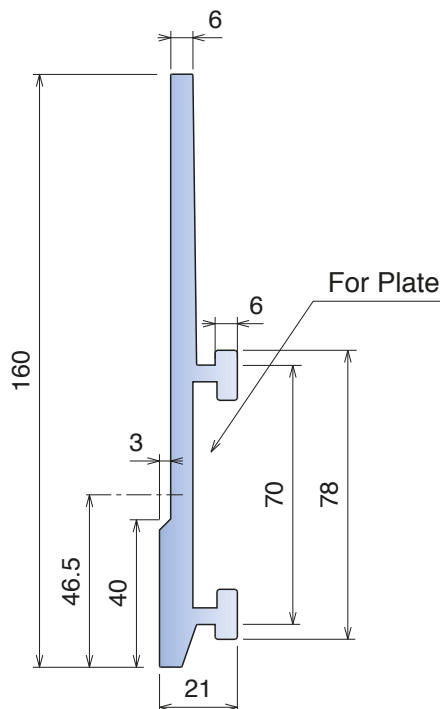
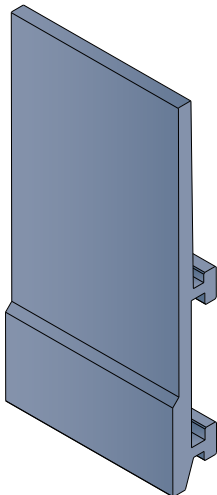

Material: Polyethylene UHMW-PE with molecular density 9,200,000 g/mo.
BluLub new material with reduced coefficient of friction and higher wear resistance.
 BluLub complies with the code of Federal Regulations of FDA. Linear expansion coefficient:
 $1.1 \times 10^{-4} \text{ } ^\circ\text{F}^{-1}$ ($2 \times 10^{-4} \text{ } ^\circ\text{C}^{-1}$) Operating temperature: -40 to 176 °F (-40 to +80 °C)

183-166-1039

Guide estruse / Extruded profiles / Extrudiertes profil

183 Guida laterale / Side guide rail / Seitenführung

Delivery: **Easy** **Standard** For plate: 40 x 8 mm

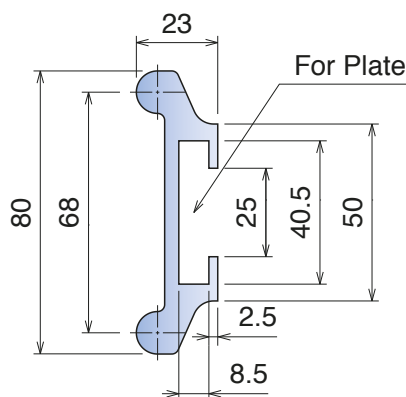
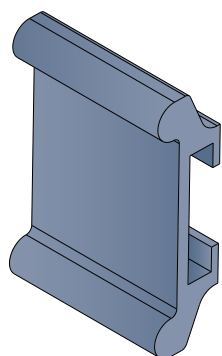

Part	Article-Nr.	L	Colour	Availability	Supply
183	18301C	3 m	black	Stock item	3 m bars
183	18301BC	3 m	BluLub	Stock item	3 m bars

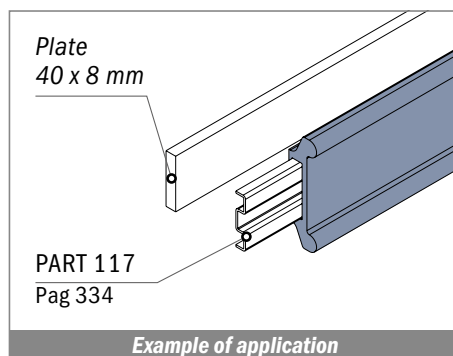

166 Profilo per tondini / Round profile for steel rods / Clip-on Profil für Rundmaterial

Delivery: **Easy** **Standard**

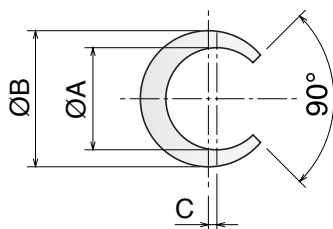
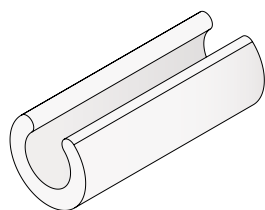

Part	Article-Nr.	A	B	C	Colour	Availability	Supply
166	16601	8	12	0,5	white	Stock item	30 m coils
166	16602	10	14	0,5	white	Stock item	30 m coils
166	16603	12	16	1	white	Stock item	30 m coils
166	16604	16	20	1,5	white	Stock item	30 m coils

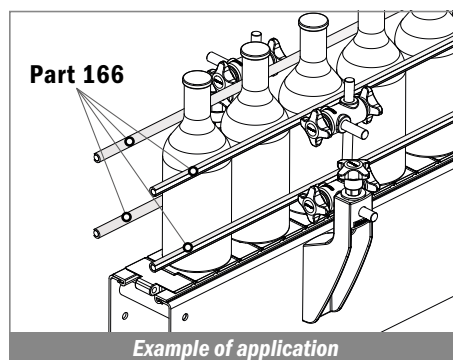

1039 Profilo per mezzitondi / Half round profile for steel rods / Halbmond Profil

Delivery: **Easy** **Standard**

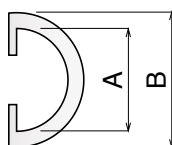
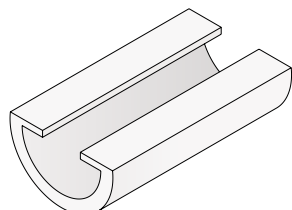

Part	Article-Nr.	L	A	B	Colour	Availability	Supply
1039	103923C	3 m	16	20	white	Stock item	3 m bars
1039	103923	6 m	16	20	white	On request	6 m bars
1039	103923-30	30 m	16	20	white	On request	30 m coils
1039	103923-60	60 m	16	20	white	On request	60 m coils

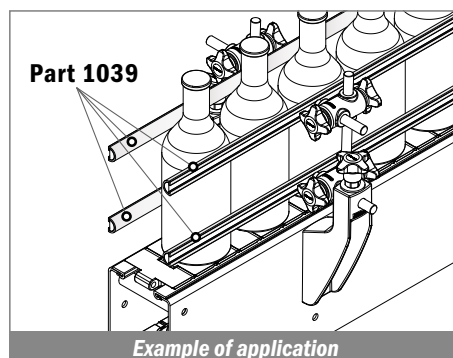

113

Pattino guida catena, centrale / Central wear strip shoe / Zentraler Einlaufschuh

Delivery: **Easy** Standard Used with PART 112 pag. 304



Part	Article-Nr.	Colour	Availability
113	11301	black	On request

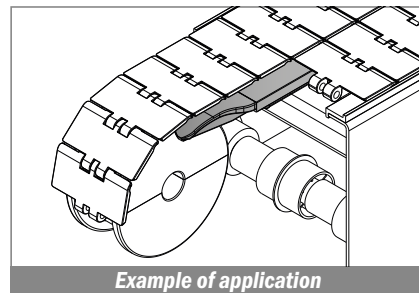
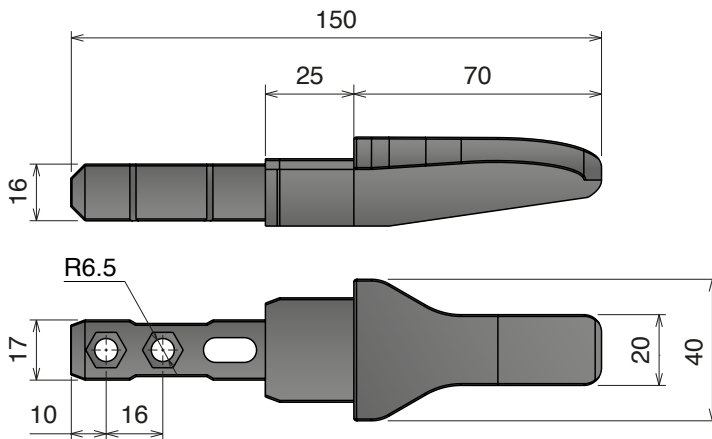

CON NERVATURA / WITH NOSE / MIT NASE

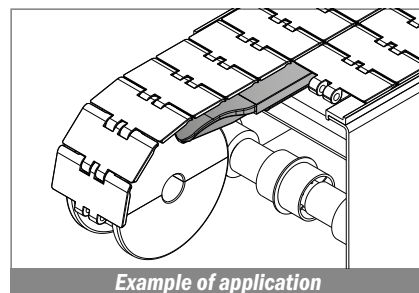
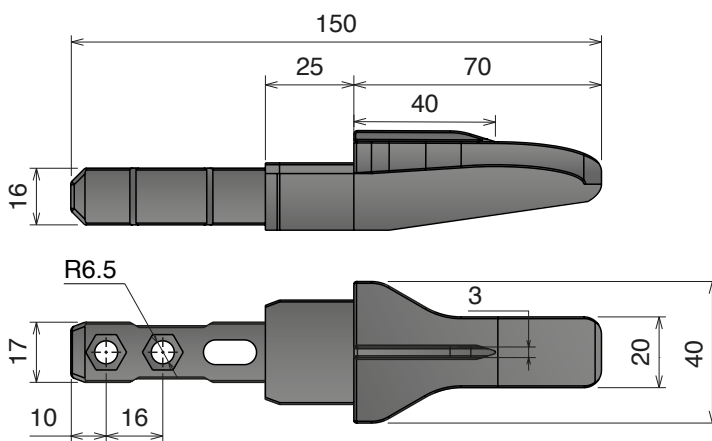

Part	Article-Nr.	Colour	Availability
113	11302	black	On request

114

Blocchetto fissaggio / Fixing clamp / Fixierblock

Delivery: **Easy** Standard Used with PART 112 pag. 304



Part	Article-Nr.	A	B	C	Colour	Availability
114	11401	10	6,2	4,5	black	On request
114	11402	13	8,2	6	black	On request

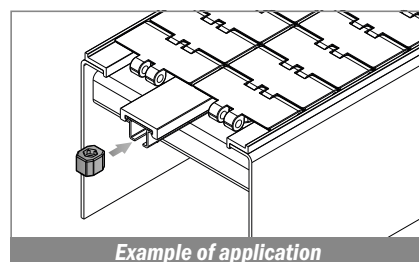
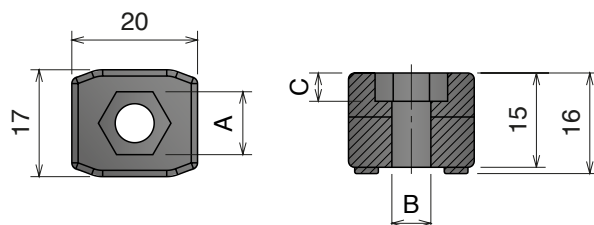

116 Pattino guida catena, laterale / Side transfer guide shoe / Seitlicher Transfer Schuh

Delivery: **Easy** **Standard** Used with PART 112 pag. 304

Part	Article-Nr.	Colour	Availability
116	11601	black	On request

LEFT VERSION

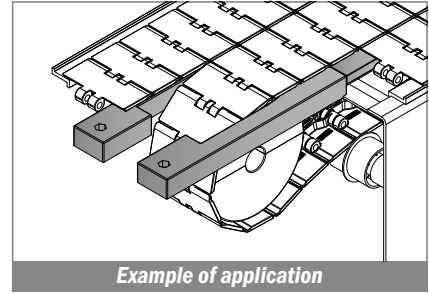
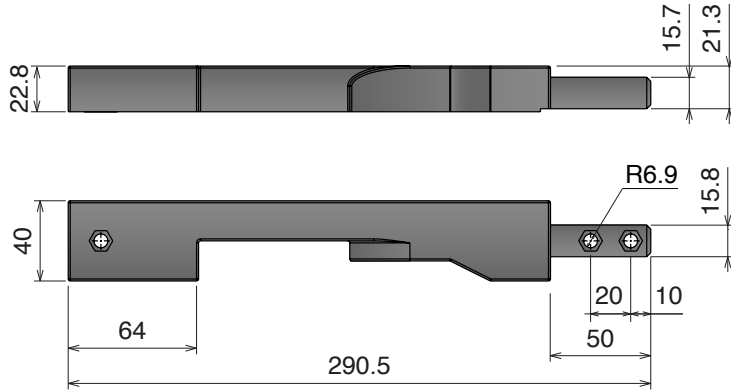

RIGHT VERSION

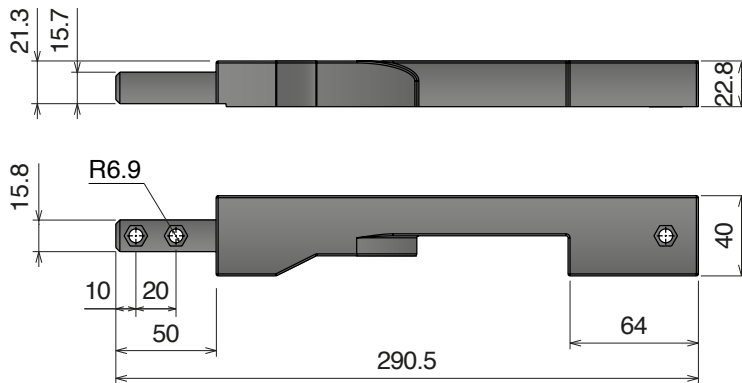

Part	Article-Nr.	Colour	Availability
116	11602	black	On request

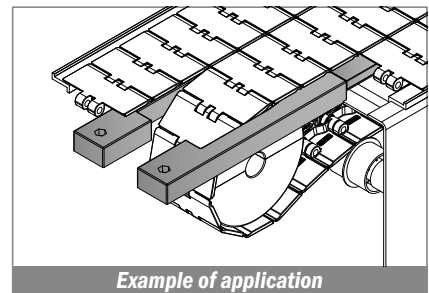

115 Blocchetto giunzione / Connecting element / Verbindungselement

Delivery: **Easy** **Standard** Used with PART 112 pag. 304

Part	Article-Nr.	A	B	C	Colour	Availability
115	11501	10	6,2	4,5	black	On request
115	11502	13	8,2	6	black	On request

